

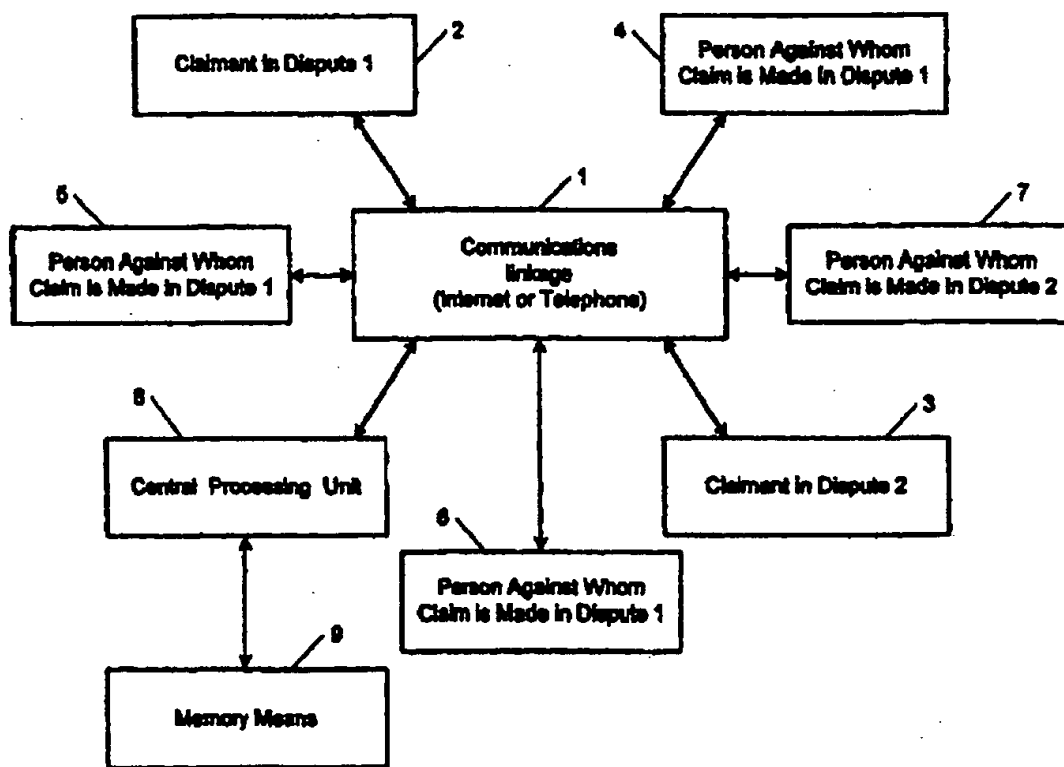

(72) BURCHETTA, JAMES D., US  
(72) BROFMAN, CHARLES S., US  
(71) CYBER\$ETTLE.COM, INC., US  
(51) Int.Cl.<sup>6</sup> G06F 17/60  
(30) 1998/08/06 (09/130,154) US  
(54) **SYSTEME ET PROCEDE INFORMATIQUES SERVANT A  
RESOUDRE UN LITIGE**  
(54) **COMPUTERIZED DISPUTE RESOLUTION SYSTEM AND  
METHOD**



(57) Système informatique servant à résoudre automatiquement un litige par l'intermédiaire d'un site Web Intranet passant par Internet ou une autre liaison de communication afin de communiquer et de traiter une série de demandes, de manière à répondre à une plainte adressée par un demandeur ou de la part de ce dernier ou

(57) A computerized system for automated dispute resolution through an Intranet website via the Internet or other communications linkage for communicating and processing a series of demands to satisfy a claim made by or on behalf of a claimant or other person involved in a dispute with at least one other person, such as a

Randell et al.

Our File CNR 5511

Ref. No. 5





(21) (A1) **2,307,497**  
(86) 1999/08/06  
(87) 2000/02/17

par une autre personne impliquée dans un litige avec au moins une autre personne, telle qu'un défendeur, son assureur ou un autre garant, ainsi qu'une série d'offres afin de régler le litige par l'intermédiaire d'au moins un processeur central incorporant un logiciel de système d'exploitation servant à commander ce processeur central. Ce système permet également, de préférence, de recueillir, de traiter et de diffuser des données de règlement générées à partir de règlements par l'exploitation du système, dans le but d'être utilisées par les garants et les demandeurs pour établir la valeur de règlement de cas futurs. Procédé servant à communiquer et à traiter une série de demandes et une série d'offres au moyen de ce système.

defendant, his insurer, or other sponsor, and a series of offers to settle the claim through at least one central processing unit including operation system software for controlling the central processing unit is disclosed. Preferably, the system also allows for the collection, processing, and dissemination of settlement data generated from settlements through the operation of the system for use by sponsors and claimants in establishing the settlement value of future cases. Also disclosed is a method for communicating and processing a series of demands and a series of offers through the system.

PCT

WORLD INTELLECTUAL PROPERTY ORGANIZATION  
International Bureau

## INTERNATIONAL APPLICATION PUBLISHED UNDER THE PATENT COOPERATION TREATY (PCT)

(51) International Patent Classification 6: <b>G06F 17/60</b>	<b>A1</b>	(11) International Publication Number: <b>WO 00/08582</b>  (43) International Publication Date: 17 February 2000 (17.02.00)
<p>(21) International Application Number: <b>PCT/US99/17737</b></p> <p>(22) International Filing Date: <b>6 August 1999 (06.08.99)</b></p> <p>(30) Priority Data: <b>09/130,154</b>      <b>6 August 1998 (06.08.98)</b>      <b>US</b></p> <p>(71) Applicant: <b>CYBERSHUTTLE.COM, INC. [US/US]; 200 Park Avenue, 16th Floor, New York, NY 10166 (US).</b></p> <p>(72) Inventors: <b>BURCHETTA, James, D.; 210 Central Park South, New York, NY 10019 (US). BROFMAN, Charles, S.; 4 Five Ponds Drive, Waccabuc, NY 10597 (US).</b></p> <p>(74) Agents: <b>HUGHES, Christopher, A. et al.; Morgan and Finnegan, L.L.P., 345 Park Avenue, New York, NY 10154-0053 (US).</b></p>	<p>(81) Designated States: <b>AE, AL, AM, AT, AU, AZ, BA, BB, BG, BR, BY, CA, CH, CN, CR, CU, CZ, DE, DK, EE, ES, FI, GB, GD, GE, GH, GM, HR, HU, ID, IL, IN, IS, JP, KE, KG, KP, KR, KZ, LC, LK, LR, LS, LT, LU, LV, MD, MG, MK, MN, MW, MX, NO, NZ, PL, PT, RO, RU, SD, SE, SG, SI, SK, SL, TJ, TM, TR, TT, UA, UG, UZ, VN, YU, ZA, ZW, ARIPO patent (GH, GM, KE, LS, MW, SD, SL, SZ, UG, ZW), Eurasian patent (AM, AZ, BY, KG, KZ, MD, RU, TJ, TM), European patent (AT, BE, CH, CY, DE, DK, ES, FI, FR, GB, GR, IE, IT, LU, MC, NL, PT, SE), OAPI patent (BF, BJ, CF, CG, CI, CM, GA, GN, GW, ML, MR, NE, SN, TD, TG).</b></p> <p><b>Published</b> <i>With international search report.</i></p>	

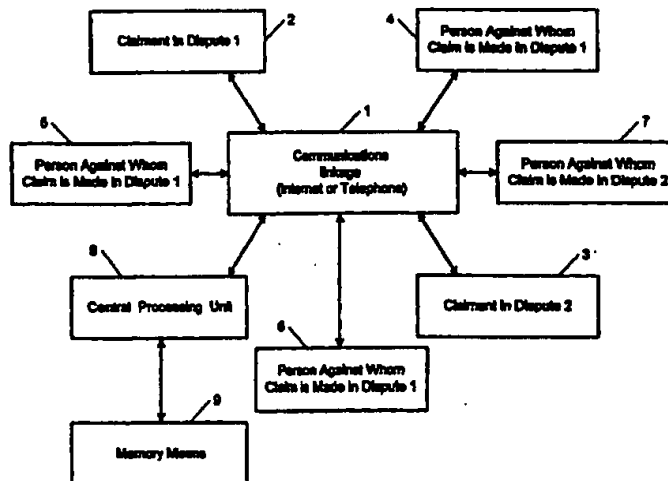
(54) Title: **COMPUTERIZED DISPUTE RESOLUTION SYSTEM AND METHOD**

(57) Abstract

A computerized system for automated dispute resolution through an Intranet website via the Internet or other communications linkage for communicating and processing a series of demands to satisfy a claim made by or on behalf of a claimant or other person involved in a dispute with at least one other person, such as a defendant, his insurer, or other sponsor, and a series of offers to settle the claim through at least one central processing unit including operation system software for controlling the central processing unit is disclosed. Preferably, the system also allows for the collection, processing, and dissemination of settlement data generated from settlements through the operation of the system for use by sponsors and claimants in establishing the settlement value of future cases. Also disclosed is a method for communicating and processing a series of demands and a series of offers through the system.

## **COMPUTERIZED DISPUTE RESOLUTION SYSTEM AND METHOD**

### **FIELD OF THE INVENTION**

This invention relates generally to dispute resolution and more  
5 particularly to on-line automated dispute resolution among adverse parties in a  
confidential environment.

### **CROSS REFERENCE TO RELATED APPLICATIONS**

This application is a continuation-in-part of application serial number  
09/130,154 filed August 6, 1998, incorporated herein by reference.

10

### **BACKGROUND OF THE INVENTION**

At the present time, it is readily apparent that a better way to resolve  
disputes has long been needed. Courtroom trials, once thought to be the only way to  
resolve legal controversies, are very costly and the outcome can be unsatisfactory for  
all concerned parties. The resulting disappointment with traditional litigation drove  
15 the creation of the alternative dispute resolution ("ADR") industry. However,  
conventional ADR, although sometimes helpful, is still costly and the results are often  
unacceptable.

An untold number of pending claims are ripe for settlement, but have  
not been resolved for reasons that have nothing to do with their merits. The present  
20 invention is based on the premise that the parties are best suited to settle those disputes  
but need a system that creates the opportunity for parties to successfully settle their  
claims easily, effectively, and inexpensively.

### SUMMARY OF THE INVENTION

In general, in a first aspect, the invention features a claim resolution method. The method involves testing pairs of non-equal values, submitted by two adverse parties for a claim, for satisfaction of a condition. If the condition is not  
5 satisfied, the method further involves testing a pair of non-equal power round values, one from each of the two adverse parties for the claim, for satisfaction of a power round condition. The method further involves calculating a binding settlement payment, when the condition is satisfied by the a pair of the non-equal values. The binding settlement payment is an amount at least equal to a lower of the pair of the  
10 non-equal values.

In general, in a second aspect, the invention features a claim resolution method. The method involves receiving values, submitted by two adverse parties for a claim. At least one of the values is submitted following a communication of a facilitating message regarding the claim, conveyed from a facilitator to at least one of  
15 the two adverse parties. The method further involves testing the pairs of non-equal values for satisfaction of a condition, and calculating a binding settlement payment, when the condition is satisfied by a pair of the non-equal values. The binding settlement payment is an amount at least equal to a lower of the pair of the non-equal values.

20 In general, in a third aspect, the invention features a dispute resolution method for resolving a claim between two adverse parties. The method involves testing pairs of non-equal values, submitted by the two adverse parties for the claim, for satisfaction of a condition. The method further involves calculating a binding

settlement payment, when the condition is satisfied by a pair of the non-equal values. The binding settlement payment incorporates a windfall adjustment, when one of the parties is a dispute entry initiator for the claim, in an amount at least equal to a lower of the pair of the non-equal values adjusted by either a positive or negative windfall  
5 differential amount.

In general, in a fourth aspect, the invention features a dispute resolution method for resolving a claim between two adverse parties. The method involves testing pairs of non-equal values, submitted by the two adverse parties for the claim, for satisfaction of a condition. The method further involves calculating a binding  
10 settlement payment, when the condition is satisfied by a pair of the non-equal values, of an amount at least equal to a lower of the pair of the non-equal values, and initiating an on-line transfer of funds between the parties for the amount.

In general, in a fifth aspect, the invention features a dispute resolution method for resolving a claim between two adverse parties. The method involves  
15 testing pairs of non-equal values, submitted by the two adverse parties for the claim, for satisfaction of a condition. The method further involves calculating a binding settlement payment, when the condition is satisfied by a pair of the non-equal values, of an amount at least equal to a lower of the pair of the non-equal values. The method further involves automatically, when the condition is satisfied, generating a settlement  
20 document for the claim containing case specific information.

In general, in a sixth aspect, the invention features systems which operate according to the disclosed techniques via an on-line interface.

Particular embodiments of the invention may feature one or more of the following advantages: lower cost for each party from initiation through resolution, versus a litigation; or an increased probability of settlement for some claims; encouragement that the case may settle; some indication that a settlement may actually

5 be reached; higher customer satisfaction with the claim resolution; attraction of a higher number of claims to the system; lower cost to initiators relative to hiring a lawyer to engage the system or file and prosecute a lawsuit; greater comfort for claimants engaging the system because the legal knowledge necessary to draft a simple dismissal, release or settlement agreement is not needed; lower cost because an

10 attorney is not needed or minimally needed to memorialize the settlement; consolidation and simplification of multiparty negotiations into effectively a two party negotiation; greater flexibility for claimants since they control the particular method of payment; faster receipt of settlement proceeds; or smaller likelihood of post settlement defaults by defendants.

15 Particular embodiments of systems incorporating the invention may feature one or more of the following additional advantages: the ability for individuals to directly contact and engage in a dispute resolution negotiation; the ability to receive an immediate or direct crediting, transfer or initiation of a transfer of the value arrived at through the settlement negotiation; or the ability to receive a windfall adjustment if

20 a negotiation results in a settlement by being an initiator.

The above advantages and features are of representative embodiments only, and are presented only to assist in understanding the invention. It should be understood that they are not to be considered limitations on the invention as defined by

the claims, or limitations on equivalents to the claims. For instance, some pairs of these advantages are mutually contradictory, in that they cannot be simultaneously present in a single embodiment. Similarly, some advantages are applicable to one aspect of the invention, and inapplicable to others. Thus, this summary of features  
5 and advantages should not be considered dispositive in determining equivalence. Additional features and advantages of the invention will become apparent in the following description, from the drawings, and from the claims.

#### BRIEF DESCRIPTION OF THE DRAWINGS

The following detailed description may best be understood by reference  
10 to the following description in conjunction with the accompanying drawings in which:

FIG. 1 is an overview of the computerized system usable to implement the present invention.

FIG. 2 is a block diagram showing how a claimant involved in a  
15 dispute interacts with the computerized system of FIG. 1.

FIG. 3 is a block diagram of an example of how an embodiment prompts a person involved in a dispute in the use of the system.

FIG. 4 is a diagram showing the program flow from a user perspective in accordance with a preferred method for  
20 operating the system of the present invention via the Internet.

FIG. 5 is an overview of the computerized system including the facilitator.



FIG. 6 is a diagram showing program flow from a system perspective for a system including a power round option.

FIG. 7 is an overview of the computerized system including the direct payment interface option.

5

### DETAILED DESCRIPTION OF THE INVENTION

A computerized system for automated dispute resolution accessible on-line, for example through an Internet website via the Internet or other communications linkage is created for communicating and processing a dispute between two persons using a series of demands to satisfy a claim and a series of offers.

10

The system compares demands and offers on a round-by-round basis in accordance with preestablished conditions.

15

A "demand" is the amount of money (or equivalent value) required by the person having a claim against another person, such as a defendant or his or her insurer, for which the person with the claim would be willing to settle. Information corresponding to the amount of the demand is entered by the claimant, or his or her representative, by using the numbers of a touch-tone or cellular telephone or the keyboard of a personal computer. An "offer" is the amount of money (or suitable value) the defendant or the insurance company will settle the claim.

20

A person involved in a dispute is anyone or any company who has a claim against another person or against whom another person has asserted a claim, whether litigation is pending or not.

The system communicates and processes the demands and the offers using at least one central processing unit by pairing offers and demands and comparing them. The computer system includes operating system software for controlling the central processing unit, a way to introduce information into the central processing unit,  
5 and memory for storing the information.

The basic preestablished conditions under which the comparison is made include the following:

If the offer in any round is less than the demand and within a preestablished percentage, for example thirty percent, of the demand in the same  
10 round, i.e. the offer is greater than or equal to seventy percent of the demand, the claim is settled for an amount in accordance with a first preestablished formula, for example, the median amount between the demand and the offer.

If the offer in any round is the same as or greater than the demand, the claim is settled for the demand amount.

15 If the offer is not within the preestablished percentage of the demand in all rounds, for example if seventy percent of the demand is greater than the offer, the claim is not settled unless the difference between the offer and demand is less than a preestablished amount, for example \$5,000, in which case the claim is settled for an amount in accordance with a second preestablished formula, for example at the median  
20 amount between the demand and the offer. Thus, first and second preestablished formulas may be the same as or different from each other depending on the agreement of the parties.

The system preferably is designed to allow a user to communicate with the system through a standard PC computer and modem via the Internet. The system may also include a voice message system or voice message generator to allow a person communicating with the system to do so through a touch-tone or cell phone linkage or to guide the person in the use of the system. Security is preferably included to make the system inaccessible without entry of the proper information, for example, a case identification number identifying the dispute, a security code corresponding to the dispute, and a user security code corresponding to the dispute and identifying the user, the user being the person or representative thereof who is making the demand or offer, for example, the attorney for the person on whose behalf the demand or offer is made.

Preferably, the computer is secure, for example by the implementation of a "firewall" or protective barrier against unauthorized traffic or the use of encryption technology, and each case is preferably triple-password protected to assure privacy and prevent unauthorized access. For example, the system may require the user to enter a password or user identification number or alphanumeric combination and a user authorization code providing access control to the system. For increased security, systems may be designed which require user authentication, for example through the use of voice pattern, fingerprints, physical signature, or "smart" card. Advantageously, if the smart card is used, certain embodiments will allow a settlement to be completed by direct transfer of funds onto the claimant's smart card.

Still further advantages may be realized when transfer of the settlement value in resolution of a given dispute can be automatically, if not immediately, be made to the claimant.

We have also recognized that some of the claims which can not be settled using the basic configuration automated dispute resolution arrangement can nonetheless be settled in an efficient automated manner which has similar advantages but removes some of the rigidity of the basic arrangement through the use of either a  
5 facilitator, a "power" round or both.

We have also recognized that yet further advantages may be achieved when a windfall relative to a normal payment is provided to an initiator, i.e. the first adversary to present a particular dispute for resolution. Initiator respondents benefit in a savings because the payment they would make relative to a normal payment for a  
10 pair of values is less. Initiator claimants benefit in a windfall increase relative to a normal payment for a pair of values.

In a fully automated system, strategies, evaluations, or other work product are directly or indirectly disclosed to anyone, including an adverse party and offers and demands that do not result in a settlement are never revealed to anyone. In a  
15 system implementing a facilitator, disclosure of information to the facilitation is limited and controlled.

Additional advantages may be achieved when settlement documents are automatically generated by the system for provision to the parties.

Figure 1 shows the basic system using the Internet or a telephone as the  
20 communications linkage.

Preferably, the central processing unit receives the settlement offers and a plaintiff or claimant enters demands in communications with the system within a

period of time, for example, 30 days. Time keeping is performed to record the entry of the demands or offers over the selected time period.

Preferably, there will be three offers for each claim in a normal negotiation arrangement. In those instances, each demand will be compared with the offer of the same number (i.e. Demand #1 to offer #1, Demand #2 to offer #2, etc.).

The computer matches the settlement offer against the claimant's demand and performs its programmed calculations in order to determine whether or not a settlement has been achieved. Where the demand and offer intersect in accordance with preestablished conditions, settlement is reached. In the intersection case where the demand is less than or equal to the offer, then the case is settled at a settlement amount equal to the demand. In the intersection case where the demand exceeds the offer, the system will preferably split the difference if the offer is also within a preestablished percentage, for example 70% of the demand (i.e.  $\text{demand} \times 0.70 \leq \text{offer}$ ). In such case, the settlement amount is calculated to be the median of the two, i.e., the demand plus the offer divided by two. If 70% of the demand is still greater than the offer, there is no settlement unless the difference between the demand and offer is less than a preestablished amount, for example \$5,000, in which case the claim is settled for the median amount between the demand and the offer.

Additionally, as a option a "power round" option may be made available. With a power round, an additional opportunity is given, or a parameter is changed to increase the prospect of a settlement being reached.

Thus, in one type of arrangement, the parties communicate only with the computer which acts as a proxy, always avoiding direct communication with each

other for purposes of negotiating a settlement. Wasteful personality conflicts, fruitless and unnecessary disagreements, posturing and positioning cannot occur, so the parties deal exclusively with the "bottom line".

Alternatively, a neutral facilitator may be used to assist with settlement negotiations. The facilitator is a computer or a person operating with, or without a computer, according to particular guidelines. Through the use of generic, non-revealing statements, the facilitator the facilitator attempts to induce one or both of the parties to the dispute to adjust their offer(s) or demand(s) into settlement range.

Figure 2 shows how a claimant involved in a dispute would use the confidential and fully automated system without direct communication with the other side.

The system preferably is also implemented securely so the system is accessible only upon entry of the proper authenticating information, such as a case identification number identifying the dispute, and a user security code corresponding to the dispute and identifying the person or representative thereof who is making the demand or offer.

Preferably, the system is capable of generating voice messages to a person communicating with the system through a touch tone or a cellular phone linkage to guide the person in the use of the system. Alternatively, written messages maybe used as prompts when the system is accessed from a personal computer via the Internet.

The entry of claims and settlement offers may also be expedited by a trained staff of computer professionals. For example, the website or telephone linkage

WO 00/08582

PCT/US99/17737

can provide a series of options, one of which places the user into on-line r telephone communication with a customer service representative to answer questions or provide other assistance. Thereafter, the user may access the system by communicating to the processing unit via the Internet or by telephone, e.g. a toll-free number, at any time or

5 day of the week to enter claims or settlement offers. Preferably, the system also has time keeping implemented to record the introduction of the information corresponding to the demands or offers over a period of time. In this way, introduction of information corresponding to demands or offers may be made in a plurality of communications with the system over a period of time. The system can of course be

10 configured to handle multiple telephone calls or other communications from anywhere in the world.

Depending upon the particular implementation, a currency converter is also included. This allows adversaries to negotiate using different currencies, for example, U.S. dollars, Euros, Pounds, Lira, or Yen, without having to take into

15 account the current exchange rate or negotiate using an unfamiliar currency. When offers or demands are entered in such a system, the system automatically converts the offer and demand into a common currency. Typically, this will be the currency specified by the claimant. Alternatively, the currency used can be based upon a joint selection by the adversaries, for example, a Japanese party and Canadian party could

20 select the Euro as the basic currency of negotiation. The computer performs its functions and the result are reported to the parties as they occur in real time without waiting.

The system includes modules which act as a negotiator proxy. This encourages and enables plaintiffs to take a realistic approach to settlement with no risk of appearing irresolute or hesitant since a claimant's financial demands that do not result in a settlement are never disclosed. Preferably, in the normal course, claimants

5 have only three or some other previously agreed-upon number of opportunities or rounds to settle claims using the system, and preferably settlement offers or rounds have only a limited period or "shelf life" in which they are operable, for example thirty days for all rounds, which encourages prompt action by claimants.

The system preferably also collects and processes settlement data

10 generated from a settlement reached through the operation of the system for dissemination and use by users, for example sponsors and claimants, in establishing the settlement value of future cases. Settlement data may also be used by facilitators in prompting one or both parties to adjust the amount they propose for settlement. Means may be provided for a user to access actual settlements achieved through the

15 use of the system in other disputes, for example, through a menu or voice choice provided to the user via telephone or the Internet whose selection provides the user with information about prior settlements. The data may be tabulated in the memory so as to be accessible by certain categories, for example by court, by sponsor, by geographic location, or by other category. In this way, a user of the system can be

20 guided in making demands and offers by actual settlements reached in similar cases.

Since the system is accessible via telephone and/or the internet, claimants need not have an attorney in order to engage the system and settle a claim. Furthermore, incentives for using the arrangement may be provided, either directly, by



giving a windfall to the party who engaged the system for the case first, or indirectly, through various payment options or tie-in arrangements.

Various enhancements can also be provided to assist the settlement process. For example, the system may be constructed to generate settlement documents for the parties and/or in some cases, papers for filing in court such as stipulations of settlement or dismissal with prejudice.

The invention can be understood readily from the following description of a number of preferred embodiments, with and without particular enhancements, in conjunction with the overview of Figure 1. The present invention provides an online system, preferably Intranet website via the Internet or telephone accessible or both, to facilitate the settlement of claims by allowing attorneys, claimants and/or claims adjusters to use a simple interface to rapidly post a series of monetary claims for a case to be tested against an algorithm for possible settlement. Preferably, the system also calculates, stores and tabulates settlement data, once a settlement has been reached, for reference by other users and/or a facilitator.

A person involved in a dispute against whom a claim has been made, such as a defendant or an insurer or other sponsor, preferably submits claims to the computerized system using electronic media and formats agreed upon by the parties. The sponsors preferably can also describe the algorithm amount and percentage, and at the individual claim level, check their potential exposure for claims with a built-in calculator provided by a computer program in the system.

Claimants can make demands directly, without hiring a lawyer, and calculate potential settlement gains for their demands. Claimants may become aware

of the system through advertising, word of mouth, links provided on selected websites and/or through affinity or partnership arrangements.

Attorneys for a claimant can make demands in return and calculate their potential settlement gain. Claimants or their attorneys may be invited to participate in the process by an automatically generated letter that is sent out once the sponsor enters the case. The claimants or attorneys may then log into the system by special authorization codes provided in the letters.

The parties involved may agree in advance to the algorithm amount and the percentage, or a first person involved in a dispute may enter this data which is then agreed to by the second person. Additionally, the parties may agree to allow for a power round. Depending upon the particular implementation, the power round may involve an additional round, a variation in some criteria and/or an agreement to alter the payment if a settlement is reached. The parties may also be subject to a windfall adjustment, based upon who engaged the system first for the claim.

In an Internet-based embodiment of the present invention, an Internet website is set up to provide the interface between system and user. Preferably, the major areas of the website include a login area for sponsors or their representatives, a login area for claimants or attorneys for claimants, and a login area for administration personnel who oversee the system. If desired, the website may also include a publicly accessible area that highlights information about the system. For increased security, a separate website may be set up with this information.

Individuals using the computerized system preferably must log into the system before they can manipulate any data. Preferably, they can view, enter and

change only that information that is within their access limits -- as an attorney for claimant, a directly accessing claimant, a sponsor user, a sponsor administrator, or a system administrator.

A sponsor user is a claims adjuster or other agent who works for a sponsor, for example an insurance company or large self-insured organization, which has entered into an agreement to use the computerized system. A sponsor user is preferably limited to entering and reviewing cases relevant to their own entered cases, not cases entered by other sponsor users of the same sponsor.

Thus, a sponsor user preferably may enter the website to login to the system, for example by using a user name and password combination or pair, read and agree to an agreement for the sponsor's participation in the system, assign new cases for claimant attorney participation, and review any completed, pending or in-process cases that have been entered into the system by that sponsor user.

A sponsor administrator is a sponsor user who has been granted administrator privileges by the sponsor. Preferably, in addition to performing all the tasks that a regular sponsor user may perform, a sponsor administrator may enter the website to change sponsor contact information, change sponsor user login and contact information, add or delete sponsor users, create sponsor users with administrator privileges, and review cases for all sponsor users within the sponsor.

Claimants or their attorneys may enter the website to login to the system preferably using a username and password pair, read and agree to a system participation agreement for the claimant, review case information as prepared by the sponsor, with current case status information, and post claims against a particular case.

Preferably, system administrators who work for a company administering the system assist in the implementation of the system. System administrators with proper authorization, for example username/password combination identifying them as such, may enter the website to review, modify, delete and create  
5 sponsors, sponsor users, and sponsor administrators, and review, modify and delete and create cases or claims to be processed by the system. Preferably, a case report writer may be provided containing current case status information searchable by date, sponsor, sponsor user, case name and status, which is able to be accessed or queried by the system administrator. A more limited form of case report writer may also be  
10 provided to claimants and other users of the system in which only information that is within the user's access limit may be searched.

The system of the present invention is preferably designed to make it easy for either a claimant directly engaging the system, or a claimant's attorney using an on-line connection such as a common Internet browser or telephone to access the  
15 system and attempt to settle a legal dispute involving a quantifiable settlement amount.

In using the system, the sponsor accesses the system, for example, with a login to the website. The sponsor may at that time enter any pertinent case information about the case and the claimant attorney. After adding or reviewing case details, the sponsor submits all at once or over time a number of settlement offers,  
20 preferably up to three, for each claim submitted. Each settlement offer is identified by Round. For example, a sponsor may enter \$40,000 as the offer for the first round (Round 1), \$60,000 for the second round (Round 2), and \$80,000 for the third round

(Round 3). If a power round option is available, the sponsor may also be prompted for information for use in the power round, if one is necessary.

If desired, in website based systems, an online calculator may be used to notify the sponsor user at that time as to what the sponsor's highest potential exposure might be. For example, if the preestablished conditions are such that the case will settle at the midpoint between the demand and offer if the offer is at least 70% of the demand or within \$5,000 of the demand, whichever is greater, a sponsor user who enters \$70,000 as the offer for a round may calculate that the possible exposure is \$85,000 (corresponding to a \$100,000 demand, i.e. the highest demand that will trigger a settlement under these conditions).

Once the claim is entered on the system, the claimant or claimant's attorney is contacted, for example by ordinary or electronic mail. (For simplicity, the claimant's attorney will be used but the discussion applies equally to the claimant and to other representatives of the claimant). The claimant's attorney chooses an attorney security code, which is preferably a unique numeric personal identification number ("pin number") that permits the attorney to access the computerized system. The claimant's attorney must also agree to be bound by any settlement achieved by the parties using the computerized system and may also at this time agree to the percentage within which a demand and offer in a round must be for settlement to occur, the formula for determining the amount of the settlement, the amount which may be zero in which the case nonetheless will settle if the difference in the demand and offer in a given round is less than or equal to that amount, and the formula for determining the amount of the settlement in that instance. The claim is now ready for

settlement, and the claimant's attorney will preferably have three normal Rounds, or opportunities, to settle a claim, which may be entered over time or all at once.

Referring now to the block diagram of Figure 2, the claimant attorney or other user (for example a defendant or sponsor) accesses the system via the Internet  
5 using any standard web browser or via an ordinary touch-tone or cellular telephone. No special equipment or training is needed by the attorney to use the system. The system "prompts" the attorney at each step of the process and provides automated, on-demand help if needed.

For example, referring to the block diagram of Figure 3, upon accessing  
10 the system, the user is met with a greeting (step 30) followed by a number of options that may be selected by pressing the appropriate number of a touch-tone or cellular telephone (step 31).

In steps 32-35, the attorney's pin number and preferably two numeric "passwords" are required to commence the alternate dispute resolution of a claim. The  
15 system preferably generates a voice confirmation of the information which the user may confirm or cancel and reenter the information (see step 34). The system may, upon confirmation of the information, determine the correctness of the information and the user's authorization to access the system for that case. After entry and confirmation of the required numbers, the attorney follows the prompts and enters  
20 demands using the telephone keypad or by typing in the demand at his or her personal computer. The system may also request confirmation of information entered by the attorney. See Figure 3 for telephone-based embodiments.

The computerized system is designed to adhere to the will of the parties and makes no attempt to "force" a settlement. No information concerning the facts, the law, or the injuries pertaining to the claim is preferably received by the system. The case can be settled only at a figure agreeable to the parties, not at some figure arbitrarily set by an interviewing third party. Even when a facilitator is used, the facilitator may only make rule driven or generic statements designed to "nudge" the parties into the settlement range and is preferably not directly privy to any of the demand(s) or offer(s) made in a subsequent round. Thus, the parties can resolve disputes fairly using the system without relinquishing settlement authority.

10                   Rounds may preferably be completed in one, two or three calls or computer sessions within a given time period, preferably thirty days. Once entered, the system instantly compares each demand to the settlement offer for each Round. If the demand and offer match or are within some preestablished range, the case is settled. For example, if the offer is within twenty percent of the demand, the claim is settled in accordance with a preestablished formula, for example the claim is settled for the median amount. If the offer and demand differ by more than twenty percent in all three Rounds, the case will not settle or, if available, will invoke a power round. If, during the normal rounds, the settlement offer is the same as or greater than the claimant's demand, the claim is settled for the demand amount.

20                   Preferably, the preestablished conditions are such that even if the offer and demand differ by more than a preestablished percentage in all three rounds, the claim will nonetheless settle if the offer and demand are within a preestablished

WO 00/08582

PCT/US99/17737

amount, for example \$5,000, in which case the claim will settle in accordance with a second preestablished formula, which may again be the median amount.

Two examples of a series of normal rounds and the results are given in Table 1. In these examples, the first preestablished formula is the median amount  
 5 between the offer and the demand. In Example 2, the preestablished amount is \$5,000 and the second preestablished formula is the same as the first preestablished formula, i.e. demand plus offer divided by two equals the settlement amount.

**TABLE 1****EXAMPLE 1** (preestablished percentage: 80% of demand)

<u>Round</u>	<u>Claimant's demand</u>	<u>Settlement Offer</u>	<u>Result</u>
1	\$200,000	\$40,000	No Settlement
2	\$150,000	\$60,000	No Settlement
3	\$100,000	\$80,000	Settled for \$90,000

**EXAMPLE 2** (preestablished percentage: 70% of demand)

<u>Round</u>	<u>Claimant's demand</u>	<u>Settlement Offer</u>	<u>Result</u>
1	\$19,000	\$4,500	No Settlement
2	\$14,000	\$6,500	No Settlement
3	\$12,000	\$8,000	Settled for \$10,000

Preferably, the system promptly notifies the parties of a settlement, for  
 10 example while the user is online or via email to offline parties or by telephone, and



follows that notice with a written confirmation. Unaccepted offers and demands expire without further action by any party, preferably after thirty (30) days.

The processing of the case data begins when a person involved in a dispute, preferably a party representing a person against whom a claim or series of claims is made, for example a sponsor, or an unrepresented claimant engaging the system, enters into the central processing unit a series of rounds of offers to settle the dispute (or if the claimant, a series of rounds of demands to satisfy the claim). The information as to a claim is submitted electronically in a format compatible with the system, for example via phone input or PC input fed for processing by the central processing unit.

Another person involved in the dispute, for example, when the first entity for the claim is a sponsor, a party representing a person asserting a claim enters a series of demands to satisfy the claim into the system. The demands and offers are entered without disclosure to other persons involved in the dispute. The series of demands and the series of offers are paired up and compared on a round-by-round basis in accordance with preestablished conditions. For example, the parties may agree to be legally bound to settle the case if the demand and the offer in any given round are identical (in which case the claim is settled for that amount) or are within a previously agreed-upon range or formula, for example, within 20% or \$5,000 or some combination (in which case the claim is settled in accordance with a previously agreed-upon formula, for example at the midpoint between the demand and the offer). Otherwise, the system goes on to the next round and the values from the previous round that did not result in a settlement are normally deleted. After each round the

system communicates to the parties the result of the value comparison, i.e. no settlement or settled at a certain amount.

The computerized alternate dispute resolution may be implemented in Internet-based embodiments using a computer program representing a distributed database application written in a Mark-up Language such as ColdFusion Markup Language and HyperText Markup Language (HTML). The system preferably is distributed through ColdFusion Server extensions which allow for interactive processing and Microsoft's SQLserver to allow attorneys and claims adjusters to access it via a standard web browser such as versions 3.0 and up of Microsoft Internet Explorer and Netscape Navigator, which can be found on a variety of platforms, including Microsoft Windows, Macintosh, and UNIX-type operating systems.

Information entered for a dispute is submitted to a central database via the Internet. The database preferably indexes sponsors, sponsor users and administrators associated with that sponsor, and cases associated with that sponsor. It also preferably indexes attorneys associated with cases.

Preferably, if a period of time passes without activity when a user is online, for example 20 minutes under normal network traffic conditions, the user is automatically logged out for security precautions. For all or a portion of the data, the system may be designed so that once data has been entered, a sponsor or other user has a period of time, for example 30 minutes, during which it can be modified or withdrawn but after which the data cannot be withdrawn.

Referring now to the flow chart of Figure 4, the preferred computer program implementing the system in a normal multi-round negotiation enters at step

10 when a sponsor user opens their web browser (for example Netscape or Microsoft Internet Explorer 3.x or 4.x) and accesses the system website. The user is prompted by a menu with a series of options, one of which is "enter as Sponsor" which is chosen. If desired, the system may automatically write information in the form of ASCII text or  
5 "cookies" onto the user's hard drive as a means of keeping track of the user and the user's use of the system. Preferably, the memory means stores this information. Upon access to the system by the user, any preexisting cookies of the user may be modified to reflect the current access of the system by the user. Unless the user has explicitly denied cookies on his or her browser, the computerized system checks for the user's  
10 name through a variable saved in the user's browser. If the user has logged in before, the user is greeted by username, provided the user is logging in with the same computer.

In step 11, the sponsor user is presented with the choice of adding/editing cases, viewing all cases for that sponsor, or logout. As mentioned previously, preferably all  
15 or a portion of the data in the system may not be withdrawn after a period of time in which event the user will no longer be permitted to modify that information.

Preferably a menu is provided in which the user may choose one of two links to separate functions. For example, a menu bar may be provided on the left hand side of the screen in which the user chooses by clicking on the appropriate box in the menu  
20 bar corresponding to the function. The user's choice is saved through intermediate login and contract screens which follow. Alternatively, step 11 may be implemented following login (step 12) discussed below.

The program next moves to step 12 in which the user must first log into the system before editing or viewing cases. The user must enter a username (unique to the entire database) and a corresponding password. If these do not match the pairs known by the system, the user is shown an error screen with the option to try again.

5 Alternately, if the user has logged in before with the same computer, his or her username may already be entered into the system, and the server which distributes the web pages checks the user's password against the username. If desired, the system may be designed so that the user has the option to enter a new or different username to allow multiple users to access the system from the same computer.

10 Computer program modules preferably are written to implement the various steps of the process. For example, a module controlling the sponsor user identity process may be created to hold all variables related to a sponsor user's identity and to cases of that sponsor.

A "ValidateNewUserName" module may be created which is called when the  
15 user places an entry in the user name field and leaves the field form. Preferably, the user name entry form has a JavaScript object which checks to see if the username has already been taken, and if so, displays an error message.

Step 13 shows the user a system participation agreement if the correct name and password were entered. The agreement preferably details the terms of use of  
20 the system and details regarding the process. Preferably, a button is provided on the menu for either agreement or disagreement with the contract. If the user agrees to the terms of the contract, he or she proceeds to the original menu choice (adding/editing

cases, or viewing cases). otherwise, the user is returned to the login screen with all information cleared.

If the user agrees to the participation agreement, the system may send the user to the original menu choice in step 11. Alternatively, the system may be  
5 designed to send the user to a menu with the options of assigning a new case, reviewing cases, adding/editing cases or logging out.

If the adding/editing cases choice was originally chosen, the program enters step 14 where an Add/Edit case screen preferably allows the sponsor to enter the following information into the database:

10

Claimant name

Case Description

Sponsor Case ID

Values for each of 3 settlement rounds

The Claimant Attorney name, firm, address, city, state, zip code,

15

telephone, fax, and email

In telephone-based embodiments, some or all of this information may be entered with the assistance of system administrators.

The Sponsor case ID is preferably a number used for sponsor internal tracking selected by the sponsor.

20

The value inputs need not all be entered at one time. The system will prompt the user to enter an amount for each round individually with the option to leave the amount for any given round blank (for entry, if necessary at a later time).

The dollar value inputs preferably include calculator functions which calculate the total possible exposure for the amount entered. The screen also may display the status of the case. Upon submitting the information, the user may be returned a confirmation screen with all entered information upon which the user can

5 choose to accept the changes or return to edit the case further. Preferably, the system provides the user with a period of time, for example, thirty minutes, to edit some or all of the case information before that information becomes final and is analyzed if corresponding values have also been submitted for the adverse party. Information made final but for which there is no corresponding counterpart, (e.g.: after the period

10 of time has expired), may be edited or withdrawn preferably only by agreement of all the parties.

Preferably, the Add/Edit screen includes a "submit" button at the bottom, which sends the information to be checked for formatting. It points out missing or improperly formatted text, or returns the text for verification. If the text is

15 accepted, the data is sent to the database for entry as an addition or update. Preferably, a sponsor user cannot edit a case in which the claimant attorney has started to submit demands into the system, except to change clerical information such as address and phone number.

A "CaseDataEntry" module may be created to hold a template that

20 processes the sponsor user's entry of case data and add/insert it into the database. The main features of the program are the checking of an expired edit time, and whether or not the claimant attorney has entered a demand in the system. In either event, the form aborts and an error message is presented.

Preferably the program is written so that when a record is to be inserted, the insertion is held up and locked using a suitable program until the system can read the record in order for the details to be displayed back to the user within the screen for confirmation and in order that the system can provide a HREF to its primary key  
5 which is automatically assigned by the database.

Another module called "SponsorAssignsCase" preferably drives the sponsor user's entry of a case into the database.

The Add/Edit calculator may be any suitable computer program, such as a JavaScript program, which applies the algorithm amounts specified by the sponsor to determine  
10 the maximum possible exposure.

If the original choice was viewing all cases, the program moves to step 15 where the View cases screen reveals all the information for a given case which has previously been entered during an Add/Edit choice. The user is also preferably given an option to edit the information, preferably with a specified time limit (e.g. 30  
15 minutes) for the rounds of offers provided a claimant attorney has not started to submit demands. The View screen may, if desired, also display a list of cases that have been assigned to a sponsor user.

Preferably, a module called "SponsorUserShow" contains a template which shows the user these records. If the sponsor user has administrator privileges,  
20 the module shows all user records related to the sponsor. A similar module called "SponsorShowCases" preferably functions to show case information.

In step 16, the user may log out of the system from a menu choice to end the session and return the user to the login screen. This menu choice preferably

also follows completion of the Add/Edit and View choices of steps 14 and 15. If a user attempts to engage the system again, he or she will have to login their user name/password pair. Preferably, logging out clears the password, but not the user name, so that upon subsequent login the computerized system may check for the user's name in the user's cookie if the user accesses the system with the same computer.

The screens appearing in the operation of the system may be created by suitable computer programs written in a Standard Generalized Mark-up Language such as ColdFusion Script.

The computer program code for the Login screen creates the login form if a user is determined not to be in a logged in state. (Fig. 4, step 12). This form preferably passes on a variable value indicating the user's eventual destination.

The module for the License screen follows the Login program and checks the user's authentication credentials. if the user passes, the License screen is shown (Fig. 4, step 13).

Preferably, a module called Login results follows the License module and sets the user state to logged in. Unless the user has explicitly denied cookies on his or her browser, the program also checks to see if the user's cookie has taken correctly and sends an error message if it does not. If all is correct, the module sends the user on to his or her selected destination.

A Logout module may be used to log a user out of the system. Preferably the next time the user tries to use a menu item, he or she will be prompted for a password and to approve the license agreement.



If the user disagrees with the license, a module following the License module displays the Disagree screen which preferably indicates that the user must agree to the license in order to use the system.

An Access Denied screen may be created to show a user who attempts  
5 to access a section he or she does not have authorization for.

A Default page for debugging purposes may also be used to show current user login status. Preferably, this page is for a system administrator, and other users would normally not be able to access this page without mentioning it explicitly.

The above-described steps preferably apply equally to sponsor  
10 administrators (sponsor users designated with administrator privileges by the sponsor). However, the system preferably may be designed so that if the user is identified as holding administrator privileges, he or she will see an enhanced version of the sponsor user menu. In addition to providing the user with the option to assign a new case, review cases, and logout, the sponsor administrator menu provides the options to  
15 change sponsor information, change his or her own user information, add a user, show/edit users, and remove a user.

If the change sponsor information option is selected, the program sends the user to change the sponsor information screen which allows the user to add/edit sponsor information stored in the database, including:

20 Sponsor Name  
Address  
City  
State

Zip Code

Phone

Fax

Email

5            If the remove a user option is selected, the program sends the user to user information screens which the sponsor user administrator can use to change, delete, or add information to any sponsor user's record to which they have access for their sponsor.

             For example, the user information screen may allow the  
10 user to add/edit the following information into the database:

User Name

Sponsor Name

Address

City

15            State

Zip Code

Telephone

Fax

Email

20            Username

Password

Active User (yes or no)

**Administrator User (yes or no)**

Computer modules preferably contain the screen forms for entering and editing sponsor user and new sponsor user information. These modules also may screen users for administrator privileges, for example, before allowing the user to edit records.

Many of the above-described steps preferably also apply to a claimant attorney, i.e. an attorney that represents an individual or company that has dispute or has initiated a lawsuit with a sponsor who has entered into a participation agreement to use the system.

The attorney may be notified, for example, by regular mail, that he or she can login to the website and submit a specified number, for example three, of demands to satisfy a claim according to preestablished conditions. The attorney may be required to sign a participation agreement, preferably mailed to him or her, before given the proper login credentials. Once the attorney signs and forwards the agreement to the system administrators, the attorney is given the proper login credentials.

In a similar manner, a claimant may contact the system to submit a dispute without going through an attorney. The claimant may be required to sign or otherwise acknowledge being bound in accordance with the participation agreement, and in some cases tender some form of payment, to engage the system.

As in the case of sponsor users, the claimant attorney opens his or her web browser and accesses the system website (See Figure 4, step 10). The attorney, however, chooses an "enter as Attorney" option provided on the menu that appears.

In step 11, the attorney is presented with the choice of reviewing cases placing demands on cases assigned to the attorney. Preferably a menu is provided in which the user may choose one of three links to separate functions via a menu bar on the left-hand side of the screen. As in the case of the sponsor user, the claimant attorney's choice is saved through intermediate login and contract screens which follow.

10 The program next moves to step 12 in which the user must first log into the system before making demands or viewing cases. A "Login" computer file for an attorney similar to the "Login" file for the sponsor preferably implements this step. Preferably, the user must enter a case identification number, a security code, for example, an internally generated random number which functions as a password), and  
15 an attorney security code (preferably, a code generated by the sponsor). If these do not match the information known by the database, the user is shown an error screen with the option to try again.

As in the case with the sponsor user, step 13 shows the claimant attorney a system participation agreement if the correct name and password were  
20 entered with the same options and results discussed previously. A "License" file similar to the "License" file for the sponsor user preferably implements this step.

If the user agrees to the terms of the agreement, he or she proceeds to the original menu choice (reviewing cases or making demands). Alternately, the

system may be designed to send the user to a main menu with the options of obtaining case information, placing a demand for the next round of the particular claim or settling a different case. A "Login-Results" file and a "Disagree" file similar to corresponding files for the sponsor- user follow the "License" file to implement this  
5 step depending on whether the claimant attorney agrees or disagrees. Similarly, "Logout", "Access-Denied", and "Default" files corresponding to similar files for sponsor users preferably are provided.

If the case information option was selected, a case information screen is provided which preferably allows the claimant attorney to view the following  
10 information from the database:

Case Name  
Status  
Claimant Name  
Attorney name  
15 Attorney firm  
Attorney address  
Attorney city  
Attorney state  
Attorney zip  
20 Attorney telephone  
Attorney fax  
Attorney email

Preferably, the screen displays the current status of the case with the corresponding details of the case without the ability of the attorney to edit any of this information. A module controlling the case status process may be written to hold all variables related to an attorney's cases.

5 An "AttorneyCaseInfo" module may also be created which displays the information an attorney needs to start making demands against a case. Preferably, the data in the module may not be withdrawn.

If the next round with current case option was chosen, the program moves to a Next Round screen which provides the attorney with the option to place a  
10 demand against a particular claim. A "CaseNextRound" module may be created to form a template which determines what the next round is, if any, and places a bid form in front of the user. Preferably, the screen provides a form box in which the attorney places the demand, and if desired menu options to either test the demand against the exposure calculator (preferably implemented by a JavaScript program applying the  
15 algorithm amounts specified by the sponsor) to determine the lowest possible amount the case will settle for, or to submit the demand.

After the attorney submits the demand for the next round, the case is submitted for comparison. A "CaseNextRound" module may be created to form a template to determine the results of the comparison based on the information that the  
20 claimant submitted on the CaseNextRound form and on the preestablished conditions. Preferably, the preestablished conditions are determined on a sponsor by sponsor basis but may also be case specific.

If the demand and the corresponding offer by the sponsor for a given round are within the preestablished conditions, the user is preferably presented with a case acceptance screen. If the demand and the corresponding offer are not within the preestablished conditions, the user is preferably presented with a link to the next round screen, if a round is available, i.e. the previously agreed number of rounds of demands has not been used and a power round is not available. If a round is unavailable, for example, the parties have agreed to three rounds and the claimant attorney has entered three rounds of demands, the user will see a message that the case is now closed in the system.

10 If the user is presented with the case acceptance screen, the claim is settled and the claimant or attorney is notified of the dollar amount of the settlement, and preferably the details of where to send the final settlement request (e.g., the sponsor's address). As shown in Figure 4, the system preferably is designed so that upon settlement of the claim, data for the settlement is collected and stored for access and use by sponsors and claimants in establishing the settlement value in future cases.

15 Preferably, the system is administrated by a system administrator who may be an employee of a third party who has been granted login rights to the administration function of the system for the purpose of adding sponsors, generating reports, or performing customer service on the website.

20 The system administrator reaches the website by opening his or her webbrowser, pointing it at the website interface and entering in appropriate identification numbers or passwords identifying him or her as an administrator. A

module may be created which contains an administrator form for the assignment or editing of a case.

The administrator may then be presented with an administrator menu which provides the following menu choices:

5 Sponsor options, including the options to add/edit a sponsor and to show a list and links to all sponsors;

User options, including the options to show users (preferably a list and links to all sponsor users, searchable by user name and sponsor name), to add a new user, and to delete a sponsor user;

10 Case options, including the options to show cases preferably by a list and links to all cases, searchable by case name, sponsor name, start date, end date and status, to assign a new case, and to delete a case; and

Site options (testing modules) including the options to clear cookies for the purpose of losing stored login information, to logout for the purpose of logging out  
15 the system and if desired to clear cookies, and to show login status for current login details.

Preferably, modules may be created to facilitate these options. For example, an "AdminNewSponsorUserEntryForm" module may be created which contains an entry form to enter a new sponsor user. Preferably, this form is different  
20 from the regular form because of the username checking that occurs during the user's interaction with the page.

An "AdminGetSponsorNewCase" module may be created which chooses a sponsor for the purpose of adding a new case. Preferably, the identity of the



WO 00/08582

PCT/US99/17737

sponsor should be known when a case is added so that the case may be properly assigned to a sponsor user.

An "AdminShowCases" module may also be created which shows all open cases in an administrator form.

5 An "AdminSponsorUserDataEntry" module may also be created to hold a template which inserts or updates a sponsor user. The module makes a query to obtain the primary identification of the user, if the system does not have this information, in order for the system to set an edit link.

An "AdminSponsorUserEntryForm" module may also be created to  
10 hold a template representing the entry form for sponsor user administrator information.

An "AdminUserShow" module may also be created which contains an administrator form to show all users.

A "CaseDataEntry" module may also be created which contains a form to enter/insert cases into the database.

15 If the Add/Edit a Sponsor option is chosen, an Add/Edit a Sponsor screen preferably appears to allow the administrator to view/edit the following information from the database:

Sponsor name

Address

20

City

State

Zip Code

Phone

Fax

Mail

Algorithm amount

Algorithm percentage

5 System ID

Active Account (yes or no)

**"SponsorDataEntry", "SponsorEntryForm", and "SponsorShow"**

modules may be created to add a new sponsor to the database and show a return page,  
to contain an entry form to enter a new sponsor, and to show a table of all sponsors  
10 entered into the system.

**"ValidateNewUserName" and "ValidateUserName"** modules may be  
created which check to see if a username exists in a sponsor table and if so, display an  
error message. Preferably, these modules are called from a JavaScript lost focus event.  
The ValidateNewUserName module preferably gives no consideration to the current  
15 username as it assumes that there is none.

The Delete User option provides the administrator with screens in  
which the administrator can change, delete or add information to any sponsor user's  
record as in the case with the sponsor administrator's remove a user option.  
Preferably, a **"DeleteUser"** module and a **"RemoveUser"** module may be created  
20 which show the form that allows a user to delete a sponsor user and perform the  
database call to remove a user.



Assigned date (start and finish dates)

Modified criteria (start and finish dates, for example, all records modified in a particular day)

Show only records unmodified by an attorney

5           The selected platform and hardware to implement the system should be scalable enough to handle large loads of traffic and data, while being responsive to user requests.

          Similarly, the database chosen should be scalable enough to handle a distributed data environment, and to be able to handle large loads of data, while being  
10 responsive to user requests.

          The application server likewise should be scalable enough to handle a distributed data environment, and to be able to handle large loads of data, while being responsive to user requests. Preferably, the application server is a popular platform in which to build applications of this type in order to support future changes, add-one,  
15 modifications, etc.

          The server preferably is an open architecture computer that has the ability for failed hardware parts to be replaced swiftly. This configuration also maintains the availability to increase the power of the machine or demand. For example, a computer having an Internal Pentium 400 MHz Processor, with 128 MB  
20 SDRAM, a pair of multi-Giga Byte Hard Drives, a Promise PCI-RAID Level 0 Controller or a RAID Level 5 Controller, a 32xCD-ROM, and 3-COM 10-BaseT Ethernet Card is suitable for use in the system.

The platform for use in the system preferably has the ability to work with open database systems, provide a reliable and scalable platform for Internet and line of business applications, and offer breed file and print services that give users easy and effective access to information and resources. For example, Microsoft Windows

5 NT Server 4.0, or 4.0 (Enterprise Edition) system, a powerful multipurpose server operating system, is a suitable platform because of its broad support of many application servers, its scalability to support the system of the present invention and its popularity with developers who create applications of this type. The platform preferably integrates the following services into underlying operating system

10 infrastructure:

Built-in networking and communication services

Comprehensive Web services for the Internet and corporate intranets

Complete platform form for distributed applications

15 Enterprise-wide directory services

Integrated and robust security services

Easy-to-use and flexible management services.

The system of the present invention preferably uses a webserver, such as Microsoft Internet Information Server 4.0, that offers proven scalability and tight integration with

20 the operating system and other products used in the system. The web server preferably includes publishing features, customizable tools, and technologies that permit the creation of Web pages, the publication of information to the World Wide Web, the sharing of files and data on operating systems such as Windows NT, Novell NetWare

and UNIX servers, and over numerous databases, including Microsoft SQL Server, oracle, and Sybase databases, and the search capacity for content in HyperText Markup Language and Microsoft office document types, and multiple languages.

Preferably, the webserver offers process isolation, a feature which  
5 protects applications and Web sites from failure caused by misbehaving components or Web-applications on the server by running them in separate memory spaces. The webserver should also have, when combined with the operating system, built-in distributed application services that automatically scale to serve thousands of simultaneous users.

10 Preferably, a high performance, open architecture, scalable database, such as Microsoft SQL Server 6.5 or 7.0, is used in the system.

In one arrangement, the computer program is preferably one which provides a scalable platform to deliver high performance Web applications with any major Web server on Windows or Solaris. Allaire ColdFusion Application Server 3.1  
15 and its cooperating ColdFusion Markup Language are suitable for use in developing the system.

In another arrangement, the computer program is preferably one which provides a scalable three-tiered platform to deliver high performance Web applications with any major Web server on Windows or Solaris. The front end is ASP/HTML, the  
20 middle tier is Com Object written in C++ or JAVA, and the back end is SQL Server and MTS.

Preferably, the system is hosted at a quality data center, such as a worldwide data center company which provides access to the Internet and monitors the servers to ensure that they are responding to Internet requests.

Although in the basic configuration there are numerous advantages to exclusively dealing with the bottom line, there is a potential disadvantage in some cases due to using specific, discrete and quantifiable criteria. Namely, lack of flexibility for close cases. In a given round, the two parties may be very close to a settlement, but unable to consummate it because they are just outside the criteria. However, since the system does not disclose the parties' proposed amounts, they will have no idea how far apart, or close, they are. For example, if, to settle the claim the differential must be within \$10,000, the same result -- no settlement -- will be reached by the basic system or method whether the differential is \$10,005 or \$75,000.

#### OPTIONAL ADDITIONS

To increase the number of claims which could possibly be settled, other optional features can be added. In particular, if the adverse parties do not meet the criteria used in normal rounds but are not far off, settlement may still be possible. Through use of a neutral facilitator, a "power round" or a combination of the two additional claims can be efficiently and expediently settled.

A facilitator may be optionally employed to communicate a "nudge" to one or more parties to a dispute into submitting a value which is more likely to result in a settlement. The facilitator acts as a neutral automaton, in that it operates in a mechanistic fashion. However, it may in fact be a live person, a computer or some

combination of the two. Figure 5 shows a representative basic system further incorporating the facilitator option. As described above, the system includes a main processor and storage representatively illustrated for simplicity as a server 50 including one or more microprocessors and memory, and an associated secure database 52 stored disk and/or tape accessible to the server. The facilitator option includes, as a minimum, rules or constraints 54 that govern the kinds of encouraging statements that facilitator may use. As shown, the facilitator is implemented so that either the completely automated or partly automated mode may be used. For the completely automated mode, the main processor is guided by programmed rules a constraints and directly communicates with the negotiating entities via the on-line interface 56 illustratively shown connected (by communication links 58, 60) to some entity's telephone 62 and another entity's computer 64. Alternatively a separate facilitator processor 66 may be used to formulate encouraging statements or access available information in order to identify one or more appropriate communications. The facilitator processor 66 communicates with the main processor to provide information for usage by the main processor, either as communicated, or after further formatting or processing. In the simplest case the facilitator processor 66 provides communications in a "ready to go" format, and the main processor merely acts as a conduit. In more complex cases, the main processor may be separately programmed to make further decisions, for example, to select from among provided encouraging statements, or to reformat a selected encouraging statement for communication to one or both entities. The facilitator may also have access to stored information in the secure database, such as offers, demands, prior settlements, geographic information, etc. The facilitator



processor 66 may also include a conventional display 68 and input device(s) 70 which allow a live person to act as part of the facilitator 66. The facilitator operates in accordance with a set of prescribed rules, distinct from the criteria for settlement. To perform its function, the facilitator may, in some arrangements, be privy to

5 information in a round that is not revealed to the adverse parties or their representatives. For example, the facilitator may know one or more of: the offer and demand in a given round, the actual numerical differential between the two, the percentage differential between the two, the amount of change or "delta" by either or both entities that would trigger a settlement of the claim, some other information

10 indicative of the potential for settlement, or any or all of the foregoing. Ideally, the facilitator will know the differentials or delta, rather than specific offers or demands, in order to insure disclosure of one party's information to an adversary does not inadvertently occur, particularly when the facilitator implementation involves a human being. Stated another way, the facilitator has some basis for knowing how close to a

15 settlement the parties are, even if the facilitator does not know specifics for either party's proposed settlement figure in one or more rounds.

In the simplest instance, the facilitator may get involved before the first value is provided by a particular party. In that case, the facilitator would likely use information provided by the parties during registration in conjunction with past

20 settlement information to provide a starting point for negotiations. For example, the facilitator might initially communicate with one or more of the adverse parties with a statement regarding the range of past settlements on record for a similar dispute.

By way of example, assume a claimant has been injured and initiated a lawsuit in a particular jurisdiction. The claimant submits the claim to a dispute resolution system incorporating a facilitator. The claimant believes the injury merits a \$200,000 settlement. Prior to the claimant submitting any values usable in a round, 5 the facilitator encourages the claimant with the statement "Similar claims have settled in your jurisdiction for between \$38,000 and \$55,000." The claimant will thus have an indication that their expectation is unrealistic. As a result, the claimant may decide not to pursue the dispute resolution, or may decide to try anyway. As a result of the encouraging, the claimant will ideally provide more realistic demands, thereby 10 increasing the prospect for settlement from the outset.

Alternatively, or in addition, the facilitator could get involved in between one or more rounds. The advantage here is that the facilitator now has available some information relating to the current state of the parties expectations for the particular dispute. Once that information is available, the facilitator would 15 communicate with one or both adverse parties in a neutral fashion in order to induce either or both to adjust their proposal to cause a settlement.

Since it is important that each party's proposed values remain undisclosed to any adversary, communications which either directly communicate amounts or deltas or indirectly allow calculation or reasonable estimation of the 20 amounts are most preferably not used. Of course, in particular implementations, there may be an unusual case where a more specific communication is warranted, but which might allow a party to reasonably estimate the adverse party's proposed number. Assume, for example, the extreme instance where the two parties' proposals were,

respectively, \$67,100 and \$66,000 and the differential for settlement was agreed to be \$1,000. The parties differ by only \$1,100. In this instance, a communication to both parties indicating "If you each give in on your amount, you WILL almost certainly have a settlement" would probably tell both parties that they were extremely close to settlement and, hence, allow an estimation of what the other entity had proposed. 5 Nonetheless, in such an extreme case, even if the parties were specifically told the proposals they would likely give in to settle. Thus, the prompting or encouraging can significantly increase the chances of a settlement.

In the specific case of a human facilitator, guidelines for formulating neutral communications and/or a set of proposed communications to be adhered to would preferably be used in order to limit the exercise of discretion and constrain the actions of the facilitator. This minimizes the possibility that either party's proposal can be estimated or known. In this manner, a greater degree of flexibility is achieved relative to a fully automated facilitator since the human facilitator can exercise some 15 discretion however, that discretion would be limited.

In the case of a fully automated facilitator or a human acting in conjunction with computer guidance, the rules or guidelines would preferably be programmed into the computer or part of a facilitator accessible knowledge base. These optional configurations more severely limit the discretion of the purely human 20 facilitator, but the computer guided human still allows one or both parties to have human interaction during negotiations, if it is desirable.

Irrespective of the whether the facilitator is a human being, a computer or some combination of the two, the statements made in the communications should be

similar. Depending upon factors such as: the identity or sophistication of the parties, the experience of the parties with the particular dispute resolution arrangement described herein, geographical considerations, etc., the statements used as prompts or encouragements may be more or less colloquial. Additionally, the statements should generally have a positive or encouraging bias in most instances so as to reassure the parties that the prospect for settlement is good. The following are a few examples considered to be representative, but by no means exclusive or exhaustive, acceptable statements or prompts:

- a) "The insurance company will increase their offer if you decrease your demand."
- b) "The claimant has significantly adjusted her demand downward, but the offer must also be increased."
- c) "You are close to a settlement but you still must give in some."
- d) "Settlement in the next round is a realistic probability if you adjust your [offer/demand]."
- e) "The parties are yards, not miles, apart."
- f) "The parties should consider reviewing the settlements reached in similar cases before the next round."
- g) "You should consider that during your negotiation two similar cases settled, one for \$125,000 and the other for \$138,000."

As an optional alternative, or supplement, to use of a facilitator, a "power" round may be used. A power round is an additional round which, by agreement of the parties or as a result of an implementation parameter, either gives a

slight advantage to one party or changes the rules in a predetermined manner, if the prescribed number of rounds does not cause settlement of the claim. Specifically, a power round may result from a specific agreement between the parties at some point in the process, or be granted based upon application of some system parameter, for

5 example, which party was the first to engage the system for the claim, the differential in the last round relative to other rounds, some mathematical analysis of the offer and demand in the most recent round(s), the amount one or both parties have adjusted their proposal per round, an analysis of the offer and demand vis-a-vis some statistical data tabulated and/or maintained by the system regarding other settlements, or other

10 suitably implemented consideration(s).

Figure 6 is shows a simplified program flow when the system includes a power round. The negotiation starts (100) when one entity submits at least one value. Once the system has a value from each entity (if there are only two), the processor receives one or more values from the first entity (102) and for the second

15 entity (104) values are paired (106) and evaluated (108). If a pair satisfy the criteria in the normal manner (110) and a settlement amount is communicated (112). This is essentially the basic system operation described above. If, however, the normal rounds do not result in a settlement, and all the normal rounds have been exhausted (114), the system will check to see if a power round for the negotiation is available (116). If not,

20 the case does not settle (118). If a power round is available, the system will then check if a power round is enabled for this particular negotiation (120). Although not required, this allows the system the flexibility to, for example, ask whether one or more entities want to "buy" a power round, invokes a facilitator intervention (if

available), prompt for criteria modification or such other modifications or features considered desirable. If the power round is not enabled (122), due to lack of willingness of an entity to buy one, or an inability of the negotiating entities to agree on the criteria, for example, the case will not settle (124). If the power round is

5 enabled, the system will perform a power round evaluation of one or more pairs of values using the power round criteria (126) or a power round guideline agreed to by the parties. As with the normal rounds, if the power round fails, the case does not settle (128). If the power round criteria is met, the case will settle. Depending upon the particular implementation, the settlement value may be subject to adjustment. In

10 that instance, the system will optionally further decide whether an adjustment is to be made (130), and what it should be (132). The system then communicates a settlement message (134) in the same general manner described above.

In one exemplary power round, following a three round limit, one party, typically the claimant, is prompted to submit a fourth value analysis in conjunction

15 with the last value (in this example, the third) value of the respondent. In this scheme, the system retains, rather than discards, at least the respondent's last value from the final normal round until the power round is complete. The claimant's fourth submission is then analyzed with the respondent's value used in the third round against using a specified criteria. Depending upon the particular system, the criteria used in

20 the first through third round can still be used, or a new criteria can be applied. For example, if the criteria applied in the first through third round was a specified percentage, the system could utilize a different criteria, for example, by changing from the percentage differential to a fixed sum differential, widening the percentage

differential, increasing the sum differential, or applying some other preselected criteria agreed to by the parties, the particular criteria allowed or applied in the power round vis-a-vis the criteria in a normal round being an implementation choice.

In any event, if the power round criteria is then satisfied, the case would  
5 settle. If not, the case would not settle. Even with the optional power round, once a settlement is, or is not, reached all offers and demands from all rounds that have not already been deleted are discarded.

Another example of a power round is to allow one party to submit multiple additional values (either offers or demands) which are each applied against  
10 the last value submitted by the adversary, until either a settlement is reached or the party gives up.

Another example of a power round is to change the settlement criteria for the final round. For example, in a five round scenario, the first four rounds would proceed using a common criteria, but for the fifth, a new or modified criteria would be  
15 applied. For example, the parties may have agreed that if a fifth round was required, the system would widen the percentage differential by 2%, increase the actual differential upward by \$1,000, or allow some specified adjustment to the formula applied, by some predetermined amount. Then, the fifth round would proceed as with the prior four.

20 In another power round variant, all of the rounds proceed according in the normal manner and, if the result is no settlement, one or more of the earlier rounds are sequentially rerun under a new agreed to criteria. This power round variant

requires keeping all the values until either the case settlement criteria is satisfied or completion of the power round still does not result in a settlement.

In yet another variant, each of the rounds is rerun but the criteria is incrementally changed. For example, if the parties agree to a 3% widening in  
5 percentage each round could be rerun, first with a 1% widening, then with a 2% widening, etc. If at any point the criteria being applied is satisfied, the dispute settles. Similarly, a widening by \$6,000 could be implemented all at once by an actual widening of \$6,000 per round, or for example, by sequential changing the amount in steps by \$6,000, \$4,000, \$2,000 and \$1,000 in each of the 1st through 4th rounds or  
10 \$2,000, \$4,000 and \$6,000 in a 3 round negotiation.

It is contemplated that still other power round variants may be straightforwardly implemented to similar effect, the important point being the provision of some additional opportunity for settlement using known, although possibly different, parameter(s) compared to a normal round.

15 As a further implementation detail, it may be desirable to impose some "cost" in return for the power round. For example, if one party gets an advantage in a power round, that party may be required to agree to a previously disclosed adjustment which will be taxed against the ultimate settlement. In other words, in this variant, a party is able to "buy" a power round at a prescribed cost. For example, if the normal  
20 payment amount would be based upon the median of the two values that triggered the settlement, a power round settlement payment calculation might involve some adjustment to less than the median for the claimant or more than the median for the sponsor or defendant. In other words, assume a settlement was triggered by an offer of



\$50,000 and a demand of \$55,000. In a round where the normal payment amount would be the median, the normal payment amount would be calculated at \$52,500. In a power round, the payment might only be \$51,250 to the claimant because the claimant agreed to a \$1,250 fixed value adjustment or a calculated adjustment of 50%  
5 of the difference between the offer and median in order to buy a power round. Similarly, if the respondent rather than the claimant bought the power round, the payment might be \$53,750.

It will be appreciated that, numerous types of adjustments may be made the important point being, there is be some quid-pro-quo on the part of the party  
10 buying the power round. Stated another way, this type of power round poses the question: "Would you give in by <some quantity> to have another chance to reach an acceptable settlement?"

It will now further be evident that alternative arrangements can combine the use of a facilitator to prompt for the use of a power round or only use the  
15 facilitator for a power round. In one scenario, the facilitator might be the one who suggests the power round after a series of unsuccessful rounds. In another instance, the facilitator might suggest changing the criteria for a power round without suggesting a particular change. This would allow for a greater possibility for settlement while not inviting either party to speculate regarding their adversary's  
20 proposals. Thus, the intervention by the facilitator would not affect the neutrality of the system. In yet another instance, the facilitator could intervene immediately upon a power round being "bought" to, for example, provide a statement derived from the tabulated data from prior settlements.

By way of example, a claimant buys a power round in return for a \$3,000 decrease in settlement payment. In this power round, the offer from the last round will be compared against a new demand. The last offer was \$100,000, the last demand was \$118,000, so the difference is \$18,000. Assume that, in order to settle, the offer and demand must be within \$12,000. The facilitator intervenes with a factual statement, derived from the tabulated data, that: "Over 75% of similar claims to yours have settled for between \$85,000 and \$110,000 in this jurisdiction" or "Your last offer/demand was off by more than 15% from the average settlement paid on similar claims in your jurisdiction." Having received one of these prompts, the claimant drops the demand to \$110,000 and the case settles. In this example, the payment is normally calculated as the median of the offer and demand which satisfied the criteria. Since the settlement resulted from a \$100,000 offer and a \$110,000 demand, the median is \$105,000. However, since the settlement resulted from a power round bought by the claimant for a \$3,000 reduction, the settlement payment would be reduced by \$3,000 to \$102,000.

Although in the basic arrangement, the settlement criteria may also differ among rounds, in some instances it is desirable to enforce a mandatory tier structure, which changes the criteria applied, based upon the demand or offer amount.

For example, the system can be set up so that for a demand or offer below \$10,000, the settlement criteria may be one or both of 30% or \$2,500. If either the offer or demand equals or goes over \$10,000, the criteria changes to 30% or \$5,000. If either the offer or demand equals or exceeds \$25,000 the criteria may change to one or both of 35% or \$8,000. Of course, the specific cut-off point, range

within which a criteria applies, or the particular percentage and/or differential amount used within a range may vary from system to system or negotiation to negotiation. Moreover, in some instances it may be desirable to allow one or more parties to specify the particulars for one or more of the above.

5                    Depending upon the implementation, it is possible for a particular demand to fall within one range and an offer to fall in another range. In that case it is preferable to require that the differential between either a) max exposure and minimum gain satisfy the broadest criteria, or b) actual differential between offer and demand satisfy the broadest criteria. Alternatively, prioritizing the usage of exposure/gain  
10 versus offer/demand, prioritizing one criteria over another, or requiring satisfaction of both criteria can be employed.

In some instances, particularly when the settlement amount is calculated to be the median, usage of a tiered arrangement can result in a settlement amount being higher than a maximum exposure or, depending upon the other options  
15 employed go below the minimum gain.

An example of such a scenario is shown in Table 2.

TABLE 2

Submission	Criteria	Specifics
\$10,000	"A"	30% or \$2,500
20 >\$10,000	"B"	30% or \$4,000
\$85,000	"C"	35% or \$10,000

WO 00/08582

PCT/US99/17737

<u>Round</u>	<u>Offer</u>	<u>Demand</u>	<u>Criteria</u>	<u>Exposure/Gain</u>	<u>Result</u>
1	\$6,000		A	\$6,900	No Settlement
		\$13,000	B	\$11,050	No Settlement
2	\$8,000		A	\$9,200	Settlement
		\$12,000	B	\$10,200	Settlement

In the above scenario, criteria A applied in both rounds for both offers because they never exceeded \$10,000. Similarly, criteria B applied in both rounds for the demands because they both were greater than \$10,000. There was no settlement in round 1 because neither the actual offer and demand nor the exposure/gain met the specified criteria.

In round 2, a settlement was reached because the \$4,000 differential criteria was met by the offer and demand and both the A and B criteria were satisfied by the exposure/gain differential.

Since the exposure/gain governs the maximum to be paid or minimum to be received, using the median of the \$8,000 offer and \$12,000 demand would result in a payment of \$10,000. However, since the maximum exposure based upon the \$8,000 offer is \$9,200, the payment amount will be set equal to that exposure rather than the median. In the reverse case, the payment amount would be no less than the minimum gain.

As a further alternative with the tiered arrangement, if the maximum exposure and minimum gain are equal, that condition could be used as a further or

alternative settlement criteria. Depending upon the implementation a match between minimum gain amount and maximum exposure could be set automatically trigger a settlement and override any other specified criteria. In the case of a match between exposure and gain, that value would also override the payment amount calculation.

5 As described herein, sponsors and attorneys may maintain an account with the provider of the dispute resolution system if they expect to submit cases for resolution with some regularity. However, it is well known that for "contingency cases", plaintiffs' attorneys can take one-third, or more, of a settlement payment for fees, expenses and/or disbursements. Advantageously, since the system is directly  
10 accessible to non-attorneys on-line, for example, via the internet or telephone, dispute resolution is directly available to the individual without the normal risks or problems which can arise from a person acting as their own lawyer. As a result, claimants and respondents may each benefit in one or more of the following ways.

There are four potential claimant benefits which can specifically result  
15 from a claimant directly initiating entry of their dispute for automated dispute resolution in the first instance. First, since the system does not deal with the law or the facts, only the bottom line, a claimant need not be sophisticated, knowledgeable in legal nuances or a capable negotiator in order to obtain an acceptable settlement. Second, the claimant is not subject to a "contingent fee" or other legal costs, although  
20 they might be charged some "engagement fee" as evidence of good faith or to discourage the submission of insignificant claims. In keeping with the on-line implementation aspect, the engagement fee will likely be chargeable to a credit card number submitted by the directly engaging party. Alternatively or additionally, the

engagement fee could be returnable if a settlement is reached, for example, if a sponsor agrees to pay a fixed fee if the dispute is negotiated using the system or a settlement is reached using the system. Third, the case may be resolved much faster than would be the case through conventional legal or dispute resolution routes since the claimant has  
5 greater control over the negotiation since they present the demands rather than authorizing an attorney to settle for no less than a specified amount. Finally, as will be discussed in greater detail below, use of the system may result in the claimant receiving their payment faster and/or more conveniently.

There are also at least three potential benefits when a defendant initiates  
10 the automated dispute resolution process for a given claim. First, legal fees are reduced because attorney involvement in the process will typically be minimal, if not nonexistent. Second, in some instances, a plaintiff may be unaware of the potential value of their claim and thus submit demands, leading to settlement, well below what the defendant could be forced to pay through conventional legal or dispute resolution  
15 channels. Finally, if a claimant can engage the system directly, rather than through an attorney, the prospect of a quick settlement goes up because delays due to backlogs or inattentiveness of attorneys to smaller claims in favor of larger ones are eliminated.

Claimants can be attracted to the system using conventional print, radio and television media, word of mouth, links on websites, partnerships with portals or  
20 web based companies, and/or through affinity program arrangements.

For example, insurance companies may offer incentives in the form of discounts on insurance products to claimants who directly engage the system.

Alternatively, a company may offer an incentive, such as a higher investment rate on

an annuity or reduced fees for a product if the claimant directly engages the system, a settlement is reached, and the proceeds are invested through the company.

Alternatively, affinity programs can be arranged with entities such as airlines or credit card companies so that, if a settlement is reached, the claimant will receive frequent  
5 flyer mileage or a debit card for the amount of the settlement. Other suitable partnerships and affinity arrangements can be set up, for example, with entities in the travel, investment, banking, automobile, publishing, housing or big ticket item businesses. Depending upon the particular circumstance a payment between dispute resolution system provider and the affinity program partner may be involved.

10 Another optional variant provides a further incentive to a party to initiate entry of a dispute for automated resolution. In this variant, if initial entry of a dispute is a result of a direct contact, the party submitting the dispute is identified as an initiator. The system logs that fact for later use if a settlement is achieved. The rounds proceed according to the particular implementation used. If a settlement is reached in  
15 a particular round however, instead of calculating a settlement amount according to the normal formula, a case resolution payment using a different formula is used which favors the initiator or alternatively a windfall amount adjustment is made to the normal payment amount which would normally be used when there was no "initiator". An example of a no "initiator" instance is when the claim is first submitted by an attorney  
20 who has an account with the system.

Depending upon the implementation, if a defendant can be a direct claimant, it may be desirable to require the defendant to "escrow" proceeds such that if a settlement is reached, the risk of post-settlement default is reduced. One way this

can be accomplished, for small matters, is by putting through a charge in a specified escrow amount on their charge/credit or debit card. Another way to accomplish this purpose is to require the person to transfer funds from an account they hold into an escrow account maintained expressly for this purpose.

5           In order to reasonably assess the amount necessary for escrow, the system can utilize the case information provided to identify similar cases which have settled and, using that information, calculate an estimation of the required escrow amount sufficient to meet a settlement, if reached. The system is also preferably set up to credit any overage amount back to the defendant's credit card or account if the  
10 settlement figure reached is less than the escrow.

          By way of example, a claimant with a currently pending claim arising from an automobile accident sees an article on a consumer oriented website about automated dispute resolution. This causes the claimant to go to the identified website which acts as an internet interface to an automated dispute resolution system. The  
15 claimant submits the claim to the system and is charged an engagement fee of \$75. Since the claimant directly contacted the system and the respondent's insurer has not previously submitted this particular claim to the system, the claimant is flagged in the system as an initiator. At some time thereafter, the insurer agrees to also use the system for that claim. The parties agree to a number of rounds and a settlement  
20 criteria, submit their respective values and the case settles as a result of the analysis in the second round. The system is set up so that a normal payment amount would be the median of the value submitted by the adverse parties. However, as part of the calculation function, the system identifies that the initiator flag is set for the claimant.



As a result, the payment is calculated differently so as to provide a windfall benefit to the claimant. For example, the claimant may receive the offer amount, an amount specified by a new formula, some percent in excess of the median amount, a fixed amount bonus, or the median might be used in place of the lower of the offer or  
5 demand in the particular formula, so as to provide a higher payment to the claimant relative to what the claimant could have obtained in the normal case.

In a similar vein, if two parties to a dispute are both individuals and the respondent is the initiator, the "windfall" would be in the form of a reduced payment amount relative to a normal payment amount.

10 In still other implementations, the "windfall" may only be invoked if there is an initiator and the demand and offer have crossed or pass each other, i.e. in one round the offer is less than the demand and in the next round the offer is more than the demand. In such a situation, the simplest windfall benefit to set the settlement payment to the initiator claimant equal to the full offered amount rather than the  
15 calculated normal payment amount. Conversely, the simplest windfall for the initiator respondent is to set the payment they will make equal to the demand.

It will be recognized that the specific windfall adjustment will depend upon the particular implementation used. Accordingly, the important aspect is that the system keeps track of whether a particular party is an initiator and there is some  
20 benefit which can accrue to the initiator when a settlement is reached.

A further advantage flowing, in part, from the on-line nature of the system is the ability to automatically provide immediate payment to a claimant or initiate an immediate transfer of the settlement payment or value when a settlement is

reached. The system Fig. 7 is a simplified system variant which includes an interface 72 to effectuate payment to the claimant automatically. For example, the interface 72 may be to a payment card account system such that if a settlement is reached, and the claimant is a registered cardholder the claimant's credit/debit/charge/entertainment  
5 card is automatically credited with the settlement amount. Similarly, if the claimant has a smart card, stored value card, online creditable purse or module, or other on-line accessible way for the recipient to automatically (and preferably directly) receive the transfer, the system may be configured to automatically credit it with the settlement amount. Given the numerous ways known to transfer or receive value on-line and the  
10 rate of growth in new ways to do so, it will be appreciated that the basic principle is the automatic provision or transfer of value, not the particular scrip, protocol or device used to do so.

Alternatively, the claimant may provide the system with an account number into which a wire transfer of the funds may be automatically transferred.

15 In some instances, the interface is merely a pre-configured vehicle for communicating with an authority in order to inform the authority that a transfer is to be made. In this manner suitable arrangements may be made so that the system can convert the settlement into a non-monetary payment-in-kind or transfer. For example, through an arrangement with an airline frequent flyer program, or other program  
20 offering "points", the settlement can be converted into the appropriate amount of miles or points. Alternatively, the settlement may involve a non-monetary settlement figure which can automatically initiate a transfer of stocks, bonds, commodities, precious metals, gems, etc., lodged with an escrow agent. In such cases, the value provided by

the respondent must be at least equal to the highest offer they will present. In the event of a settlement, the appropriate amount is calculated as the settlement figure and automatically transferred to the claimant. For example, in the case of stocks, the shares will be automatically registered in the name of the claimant. In the case of  
5 precious metals, an account will be automatically opened in the claimant's name and a suitable amount will automatically be credited to that account. It will be recognized that, consistent with the description herein, automated dispute resolution would be extensible to apply to other payment-in-kind situations in a straightforward manner.

It may also be desirable to implement the system such that, in response  
10 to a settlement, an automatic transfer of title or an ownership interest in something is initiated, for example in the case where the dispute is a divorce and the payment may be made by transfer of title in a vacation home from one to the other party. In such a case, suitable documents authorizing the transfer will be executed but not filed. If a settlement is reached, the system will automatically notify the appropriate entities and  
15 provide the necessary documents to effectuate the transfer with a minimum of claimant involvement.

Additionally variants may initiate issuance of some insurance product, such as an annuity or a fully paid up insurance policy in the settlement amount.

One possible drawback to a system which allows a claimant to directly  
20 engage the system is the claimant's potential fear that, even if a settlement is reached, attorney involvement may be required in order to consummate the settlement. Advantageously, the system may be optionally constructed to address that concern. In particular, the system may be constructed to automatically generate settlement

documents when a settlement is reached. As described above, when the parties engage the system one or more of the parties provide case specific information. The system contains a number of templates which can be used to generate settlement documents appropriate for the case. For example, a settlement agreement and/or release can be  
5 generated by extracting the appropriate information provided for the case and incorporating it into the template. Similarly, if sufficient information is provided for a dispute currently pending in a court, the system can use a suitable template to generate a stipulation and/or order of dismissal with prejudice, in accordance with the requirements of the particular jurisdiction. Once generated, the document can be  
10 accessed in a form conducive to printing and immediate execution or in a text format which allows further additions and/or modifications to be made to conform to local rules or custom. In the broadest sense, the on-line document feature can be likened to an having an automated clerk make a trip to the local stationary store for the appropriate legal form and type in the appropriate information. Alternatively,  
15 particular jurisdictions may restrict the form and type of document provided. As a result, the system is preferably constructed so as to take into account any such limits and restrictions within that jurisdiction and provide all appropriate disclaimers in that regard.

#### Multiparty Aggregation Options

20 Many multiparty negotiations can be directly handled as a group of two party negotiations as set forth above. However, in some cases, particularly when the claim involves a single entity against a group of entities for a claim, aggregation of the group's individual offers or demands can simplify processing.

Depending upon the particular system, the aggregation can be fully or partly blind to some or all of the parties. For example, if a plaintiff has a claim against three separate parties (collectively "the group", the group can be linked such that the system will still accept individual submissions from each. However, once received,

5 individual submissions from each member of the group will be added to corresponding submissions of the others in the group to form one or more sets of aggregate values. The system is "fully blind" because the individual members of the group are not informed that the aggregation is being performed. An aggregate value is used in the system as if it was an offer or demand submitted by a single entity. In this system, an

10 "AggregateValues" module can be created which sums individual values from different entities sharing a common adversary for a claim. The system will compare the aggregate value against an opposing offer or demand as described above. In other words, once aggregated, the negotiation can proceed as if it was a two party negotiation -- because from the system perspective at that point, it is.

15 It is important to note that, as with the two party negotiation, values submitted by all members of the group are not disclosed to their adversary. Similarly, the system does not disclose the adversary's submission to any member of the group. Depending upon the particular system configuration, the submissions from individual members of the group may not be disclosed to any other member of the group.

20 In the case of a fully blind aggregation arrangement, individual submissions are not revealed to anyone other than the party making that submission.

An example of a fully blind negotiation is shown in Table 3

TABLE 3

Depending upon the particular system, the aggregation can be fully or partly blind to some or all of the parties. For example, if a plaintiff has a claim against three separate parties (collectively "the group", the group can be linked such that the system will still accept individual submissions from each. However, once received,

5 individual submissions from each member of the group will be added to corresponding submissions of the others in the group to form one or more sets of aggregate values. The system is "fully blind" because the individual members of the group are not informed that the aggregation is being performed. An aggregate value is used in the system as if it was an offer or demand submitted by a single entity. In this system, an

10 "AggregateValues" module can be created which sums individual values from different entities sharing a common adversary for a claim. The system will compare the aggregate value against an opposing offer or demand as described above. In other words, once aggregated, the negotiation can proceed as if it was a two party negotiation -- because from the system perspective at that point, it is.

15 It is important to note that, as with the two party negotiation, values submitted by all members of the group are not disclosed to their adversary. Similarly, the system does not disclose the adversary's submission to any member of the group. Depending upon the particular system configuration, the submissions from individual members of the group may not be disclosed to any other member of the group.

20 In the case of a fully blind aggregation arrangement, individual submissions are not revealed to anyone other than the party making that submission.

An example of a fully blind negotiation is shown in Table 3

TABLE 3

WO 00/08582

PCT/US99/17737

Settle if (aggregate)offer is at least 75% of demand

Fully Blind (i.e. Party 1, 2 & 3 and plaintiff do not know offers are combined).

EXAMPLE 1:

ROUND 1

5	Defendant(s)	Plaintiff
	Party 1 Offer \$10,000	
	Party 2 Offer \$15,000	
	Party 3 Offer <u>\$35,000</u>	
	Total \$60,000	Demand = \$65,000
10	Case settles for \$62,500	
	Party 1 contributes \$10,416.67 ( $10,000/62,500 \times \$62,500$ )	
	Party 2 contributes \$15,625.00 ( $15,000/62,500 \times \$62,500$ )	
	Party 3 contributes \$36,458.33 ( $35,000/62,500 \times \$62,500$ )	

15 EXAMPLE 2:

ROUND 1

20	Defendant	Plaintiffs
		Party 1 Demand \$25,000
		Party 2 Demand \$18,000
		Party 3 Demand <u>\$35,000</u>
	Offer = \$70,000	Total \$78,000
	Case settles for \$74,000	
	Party 1 receives \$23,718	

Party 2 receives \$17,077

Party 3 receives \$33,205

A partially blind arrangement allows the group access to each other submissions. To prevent escalation in submissions by one individual based upon the submission of another on the group, it is desirable to only allow an individual access to the submissions of others in the group after all the individual values have been submitted and the values have been locked against withdrawal or change.

An example of this type of partially blind negotiation is shown in table

4

10

**TABLE 4**

Settle if demand and offer differ by less than \$2,500

Partially Blind (i.e. Party 1, 2 & 3 know each others offers after all submitted)

**ROUND 1**

15 Defendant(s) Plaintiff

Party 1 Offer \$5,000

Party 2 Offer \$12,000

Party 3 Offer \$9,000

Party 4 Offer \$11,500

20 Total \$37,500 Demand = \$50,000

**NO SETTLEMENT**

**ROUND 2**

Defendant(s) Plaintiff



WO 00/08582

PCT/US99/17737

Party 1 Offer \$10,000

Party 2 Offer \$15,000

Party 3 Offer \$10,000

Party 4 Offer \$13,500

5                    Total \$48,500            Demand = \$45,000

Case settles for demand amount of \$45,000

Party 1 contributes \$9,278.35

Party 2 contributes \$13,917.53

Party 3 contributes \$9,278.35

10                    Party 4 contributes \$12,525.77

Another partially blind arrangement allows the group to fully collaborate on a collective submission. In this case, the adversary is informed that the offer or demand is being submitted on behalf of party 1, party 2, etc. The adversary

15 then has the option of accepting or declining. If the adversary accepts, and a settlement is reached, the claim will be settled for all parties in the group and their adversary.

An example of this type of multiparty negotiation is shown in table 5.

TABLE 5

20    Settle if (aggregate)offer is at least 75% of demand

Partially Blind (i.e. Party A, B & D collectively submit offers as single values and plaintiff is informed, "You have a claim against Entities A, B, C & D. Offers are being submitted by Entity A on behalf of Entities A, B & D. Entity C declines to

participate, if a settlement is reached you may be able to independently pursue your claim against Entity C."

<u>Round</u>	<u>Aggregate Offer</u>	<u>Claimant's demand</u>	<u>Result</u>
1	\$100,000	\$295,000	No Settlement
2	\$110,000	\$230,000	No Settlement
3	\$120,000	\$160,000	Settle for \$140,000
4	\$128,000	\$140,000	

Entities A, B and D can then work out among themselves the apportionment, specify an apportionment so that the system will calculate an amount owing for each, or  
 5 apportion the amount equally among all participants.

In still another variant, once presented with the list of parties making up the group, the adversary has the option of declining to negotiate with the group, but designating some members of the group with whom they will negotiate as a group. In this manner, a plaintiff gets the ability to "opt out" one or more particular  
 10 defendants, so as to attempt to preserve a claim against them, and a defendant gets to opt out one or more plaintiffs, to prevent one or more individuals, for example, those with a history of dubious claims, from riding on the claims of others.

The aggregations may also be independently performed on both sides of a claim. Thus, a group may submit offers for comparison against another group's  
 15 demands. Depending upon the particular implementation, the aggregation arrangement on one side of the claim need not be the same as the aggregation performed on the other side of the claim. In other words, offers may be submitted

partially blind for comparison against demands aggregated in a fully blind arrangement.

In any case, if a settlement is reached, if the group whose submissions were aggregated will pay on the claim, the payment will preferably be on a pro-rata proportional share. Alternatively, in some implementations, the members of the group  
5 can specify a payment allocation other than on a pro-rata basis.

If the group is made up of individual parties who will receive payment, depending upon the particular system, the parties will each receive their respective demands, rather than some median. Alternatively, additional modules can be created  
10 which perform more complex apportionment or allocation of payments to plaintiffs.

#### Additional Options

Since the internet is a globally accessible media, particular embodiments may include a "ConvertEquateLocalCurrency" module created to allow adverse parties to submit offers or demands in their local currency for comparison,  
15 even if the offers are submitted in one currency and the demands in another. In this manner, each party can deal with a currency with which they are comfortable, thereby making the negotiation even more user friendly. Where disparate currencies are used, to analyze the offers and demands the system will convert the all the currencies specified to a common currency, which may or may not be the same currency as the  
20 offers and demands, for comparison. By way of example, if the offers were submitted in Japanese Yen and demands submitted in Italian Lira, the system might use Yen, Lira, or some third currency, for example U.S. Dollars, Euros, or even Thai Bhat, depending upon the particular implementation.

In a similar vein, an arrangement may be made with a currency exchange entity so that, if a settlement is reached, the claimant can be paid in the currency of choice, irrespective of the currency the respondent used to submit offers. For example, a Greek national submitting offers or demands in U.S. dollars may  
5 specify automatic payment by crediting their Athens bank account in Drachmae.

Other optional features include a "StructurePayment" module which will calculate a structured payment from the settlement amount in accordance with specific guidelines submitted by a party. In this manner, spendthrift claimants can protect themselves by specifying that the payment not be provided as a lump sum, but  
10 rather incrementally over time. Coupled with one of the above payment options, the settlement could advantageously make monthly transfers to a stored value module, a credit card, a bank or brokerage account, quarterly payments to an insurance policy, or such other arrangements as the system provider can arrange.

Other optional features include the use of different types of  
15 communications links (e.g. optical cables or wireless connections); distributed databases; state machines; combinations of secure and non-secure servers; distributed processing; or implementing certain options such as indicators or particular functions in hardware vs. in software and vice versa. Similarly, the principles may be implemented using different types of storage such as tape, solid state, optical,  
20 magneto-optical, etc., instead of, or in addition to those described herein.

It should be understood that the above description is only representative of illustrative embodiments. For the convenience of the reader, the above description has focused on a representative sample of all possible embodiments, a sample that

teaches the principles of the invention. The description has not attempted to exhaustively enumerate all possible variations or even combinations of those variations described. That alternate embodiments may not have been presented for a specific portion of the invention, or that further undescribed alternate embodiments may be available for a portion, is not to be considered a disclaimer of those alternate  
5 embodiments. One of ordinary skill will appreciate that many of those undescribed embodiments, involve differences in technology rather than differences in the application of the principles of the invention. It will be recognized that, based upon the description herein, most of the principles of the invention will be transferable to  
10 other specific technology for implementation purposes. This is particularly the case when the technology differences involve different specific hardware and/or software. Accordingly, the invention is not intended to be limited to less than the scope set forth in the following claims and equivalents.

**What is Claimed is:**

1. A computer executable method for dispute resolution, operative to control a computer and stored on a computer readable media, the method when  
5 executed comprising:
  - a) receiving a plurality of demands from a first party for a claim;
  - b) receiving a plurality of settlement offers from a second party for  
the claim;
  - c) preventing disclosure of the demands to the second party, and  
10 preventing disclosure of the settlement offers to the first party;
  - d) calculating differences between the demands and the settlement  
offers in rounds, each of the differences being calculated in a round using one demand  
and one settlement offer, the one demand and the one settlement offer being unequal in  
value;
  - 15 e) determining whether any of the differences fall within a  
predetermined criteria;
  - f) if any of the differences fall within the predetermined criteria,  
transmitting a message to the first party and the second party that the claim is resolved;  
and
  - 20 g) if the differences do not fall within the predetermined criteria,  
transmitting a message that the claim has not been resolved.
2. The method of claim 1 wherein the one demand is received  
before the one settlement offer.
- 25 3. The method of claim 1 wherein the one demand is received after  
the one settlement offer.
4. The method of claim 1 further comprising:

limiting the plurality of settlement offers which may be received to a maximum of three.

- 5           5.     The method of claim 1 further comprising:  
allowing one of the parties to specify a maximum number of rounds.
6.     The method of claim 1 wherein d), e), f) and g) are performed  
after receiving less than a maximum specified number of the plurality of demands.
- 10           7.     The method of claim 1 wherein all settlement offers are received  
before any of the demands are received.
8.     An automated method of settling a dispute between at least two  
parties using monetary demands and settlement offers, comprising:  
15           receiving an engagement request from a first party to engage an  
automated dispute resolution system, for a claim, and to be bound by a resolution of  
the claim transmitted from the automated dispute resolution system;  
          receiving an engagement indication from a second party to engage the  
automated dispute resolution system for the claim;  
20           receiving a series of at least three monetary demands from the first  
party;  
          receiving a series of at least three settlement offers from the second  
party;  
          maintaining inaccessibility of the monetary demands from the second  
25           party;  
          maintaining inaccessibility of the settlements offers from the first party;  
          comparing a first demand of the series of monetary demands with a first  
settlement offer in a first round to determine if a first difference between the first  
monetary demand and the first settlement offer is within a predetermined guideline;

if, in the first round, the first difference is within the predetermined guideline, transmitting a successful dispute resolution notification to the first party and the second party;

5 if, in the first round, the first difference is not within the predetermined guideline, comparing a second demand of the series of monetary demands with a second settlement offer in a second round to determine if a second difference between the second monetary demand and the second settlement offer is within the predetermined guideline;

10 if, in the second round, the second difference is within the predetermined guideline, transmitting a successful dispute resolution notification to the first party and the second party;

15 if, in the second round, the second difference is not within the predetermined guideline, comparing a third demand of the series monetary demands with a third settlement offer in a third round to determine if a third difference between the third monetary demand and the third settlement offer is within the predetermined guideline; and

20 if, in the third round, the third difference is within the predetermined guideline, transmitting a successful dispute resolution notification to the first party and the second party.

9. The method of claim 8, wherein if, in all of the first, second and third rounds, the first, second and third differences are not within the predetermined guideline, transmitting an unsuccessful dispute resolution signal to said first party and said second party.

25 10. The method of claim 8 wherein, if in any round, the successful dispute resolution notification is transmitted, the method further comprises:

generating a settlement value notification including a settlement amount to be paid to the first party by the second party.



11. The method of claim 10 further comprising:  
calculating the settlement amount using at least the monetary demand  
from the round in which the successful dispute resolution notification is transmitted.
- 5 12. The method of claim 11 wherein the calculating also uses the  
settlement offer.
13. The method of claim 8 wherein, if, in any of the first, second or  
third rounds, the successful dispute resolution notification is transmitted, the method  
10 further comprises:  
calculating a payment value for the claim from a pair of values used in  
the round for which the successful dispute resolution notification is transmitted; and  
storing the payment value in an engaging party accessible database.
- 15 14. The method of claim 8 wherein in the first round the first  
difference is not within the predetermined guideline, the method further comprising:  
rendering the first monetary demand and the first settlement offer  
unavailable to the automated dispute resolution system for the second round.
- 20 15. The method of claim 14 wherein in the second round the second  
difference is not within the predetermined guideline, the method further comprising:  
rendering the second monetary demand and the second settlement offer  
unavailable to the automated dispute resolution system for the third round.
- 25 16. The method of claim 15 wherein in the third round the third  
difference is not within the predetermined guideline, the method further comprising:  
rendering the third monetary demand and the third settlement offer  
unavailable to the automated dispute resolution system.
- 30 17. The method of claim 10 wherein the settlement amount is a  
median of one demand and one settlement offer.

18. The method of claim 10 wherein the settlement amount is equal to an amount specified by one demand.

5 19. The method of claim 8 wherein the predetermined guideline is that a single settlement offer and a single demand differ from each other by less than a fixed amount.

20. The method of claim 19 wherein the fixed amount is \$5,000.

10

21. The method of claim 19 wherein the fixed amount is a calculated amount representing a percentage of one of the single settlement offer or the single demand.

15 22. The method of claim 8 wherein the specified condition is that a single settlement offer is within a predetermined percentage of a single demand.

23. The method of claim 22 wherein the predetermined percentage is 70%.

20

24. The method of claim 22 wherein the predetermined percentage is 80%.

25 25. The method of claim 8 wherein one of the series of three monetary demands is received before one of the series of three settlement offers.

26. The method of claim 8 wherein one of the series of three settlement offers is received before one of the series of three monetary demands.

30 27. An automated method of settling a dispute between adverse parties involving monetary values submitted by the adverse parties comprising:

receiving an engagement request from a first entity to engage an automated dispute resolution system, for a claim, and to be bound by a resolution of the claim transmitted from the automated dispute resolution system;

receiving an engagement indication from a second entity, adverse to the  
5 first entity with respect to the claim, to engage the automated dispute resolution system for the claim;

encouraging at least one of the first entity or second entity with a facilitator communication;

receiving a series of at least two monetary demands and a power round  
10 demand from the first entity;

receiving a series of at least two settlement offers from the second  
entity;

maintaining inaccessibility of the monetary demands from the second  
entity;

15 maintaining inaccessibility of the settlements offers from the first  
entity;

comparing a first demand of the series of monetary demands with a first  
settlement offer in a first round to determine if a first difference between the first  
monetary demand and the first settlement offer is within a predetermined guideline;

20 if, in the first round, the first difference is within the predetermined  
guideline, transmitting a successful dispute resolution notification to the first entity  
and the second entity;

if, in the first round, the first difference is not within the predetermined  
guideline, comparing a second demand of the series of monetary demands with a  
25 second settlement offer in a second round to determine if a second difference between  
the second monetary demand and the second settlement offer is within the  
predetermined guideline;

if, in the second round, the second difference is within the  
predetermined guideline, transmitting a successful dispute resolution notification to the  
30 first entity and the second entity;

if, in the second round, the second difference is not within the predetermined guideline, initiating a third round as a power round by comparing the power round demand of the series monetary demands with one settlement offer, from the series of at least two settlement offers, to determine if a power round difference  
5 between the power round demand and the one settlement offer is within a predetermined power round guideline; and

if, in the power round, the power round difference is within the predetermined power round guideline, transmitting a successful dispute resolution notification to the first entity and the second entity.

10

28. The method of claim 27 wherein, if in any round, the successful dispute resolution notification is transmitted, the method further comprises:

generating a case resolution payment to be paid to the first entity by the second entity which incorporates a windfall amount adjustment.

15

29. The method of claim 27 further including:

prompting at least one of the first entity or second entity, prior to at least one of the first, second or third rounds, for submission of a monetary value using a statement that does not reveal any demand to the second entity or any settlement  
20 offer to the first entity.

30. The method of claim 27 wherein when a successful dispute resolution notification is transmitted, the method further comprises:

calculating a settlement payment of a specified value to be paid to the  
25 claimant to settle the case; and  
automatically initiating the settlement payment to the claimant.

31. The method of claim 27 further including:

automatically generating case settlement documents containing dispute  
30 specific information for transmission to the adverse parties.

32. A dispute resolution method for resolving a claim among adverse parties, the method comprising:
- testing non-equal values in a round, one value submitted by one of the adverse parties for the claim, another values submitted by another averse party for the claim; and
  - calculating a binding settlement payment of an amount at least equal to a lower of the pair of the non-equal values, when a settlement determination algorithm used in the testing is satisfied by the pair of the non-equal values.
33. The method of claim 32 further comprising:  
limiting the settlement payment to the greatest of the non-equal values.
34. The method of claim 32 further comprising:  
receiving at least one of the non-equal values on a weekend day.
35. The method of claim 32 further comprising:  
receiving at least one of the non-equal values at a time other than between 9 a.m. and 4 p.m. on a weekday.
36. The method of claim 32 further comprising:  
storing the amount correlated to case specific information in a database.
37. A claim resolution method comprising:  
testing non-equal values, submitted by adverse parties for a claim, for satisfaction of a condition;  
if the condition is not satisfied, testing non-equal power round values, one from each of the adverse parties for the claim, for satisfaction of a power round condition; and  
calculating a binding settlement payment, when the power round condition is satisfied by the non-equal power round values, of an amount at least equal to a lowest of the non-equal values.

38. A claim resolution method comprising:  
receiving values, submitted by adverse parties for a claim, at least one  
of the values having been submitted following a communication of a facilitating  
5 message regarding the claim, conveyed from a facilitator to at least one of the adverse  
parties;  
testing the non-equal values for satisfaction of a condition; and  
calculating a binding settlement payment, when the condition is  
satisfied by the non-equal values, of an amount at least equal to a lower of the pair of  
10 the non-equal values.
39. A dispute resolution method for resolving a claim among  
adverse parties, the method comprising:  
testing non-equal values, submitted by the adverse parties for the claim,  
15 for satisfaction of a condition; and  
calculating a binding settlement payment, when the condition is  
satisfied by the non-equal values, the binding settlement payment incorporating a  
windfall adjustment when one of the parties is a dispute entry initiator for the claim in  
an amount at least equal to a lowest of the non-equal values adjusted by either a  
20 positive or negative windfall differential amount.
40. A dispute resolution method for resolving a claim among  
adverse parties, the method comprising:  
testing non-equal values, submitted by the adverse parties for the claim,  
25 for satisfaction of a condition;  
calculating a binding settlement payment, when the condition is  
satisfied by the non-equal values, of an amount at least equal to a lowest of the non-  
equal values; and  
initiating an on-line transfer of funds to at least one of the adverse  
30 parties for the amount.

41. A dispute resolution method for resolving a claim between two adverse parties, the method comprising:

testing non-equal values, submitted by the adverse parties for the claim, for satisfaction of a condition;

5 calculating a binding settlement payment, when the condition is satisfied by the non-equal values, of an amount at least equal to a lowest of the non-equal values; and

automatically, when the condition is satisfied, generating a settlement document for the claim containing case specific information.

10

42. A method of automated on-line dispute resolution comprising:

maintaining an interface to the internet through which a claimant can submit demands for a claim to a dispute resolution system and receive indications therefrom such that, when the claimant submits multiple demands, via the interface, to  
15 the dispute resolution system and the dispute resolution system pairs the multiple demands with offers of settlement for the claim on a one-to-one basis, a comparison will be performed in accordance with a criteria and if the criteria is not satisfied, will perform a power round analysis of a demand and an offer in accordance with a power round criteria and, following the power round, the claimant will be provided with  
20 either a positive or negative indication, via the interface, as to whether or not the power round criteria is satisfied.

43. An on-line dispute resolution system comprising:

maintaining an interface to the internet through which a claimant can  
25 submit a demand for a claim, following receipt by the claimant of an on-line encouragement from an automaton facilitator, and receive back a positive or a negative indication for the claim such that, when the claimant submits multiple demands via the interface, the system will pair the multiple demands with offers of settlement for the claim on a one-to-one basis and perform a comparison in accordance with a criteria,  
30 the claimant will be provided with an indication, via the interface, as to whether or not the criteria is satisfied.

44. A method of automated on-line dispute resolution comprising:  
maintaining an interface to the internet through which a claimant can  
submit demands for a claim to a dispute resolution system and receive indications  
5 therefrom such that, when the claimant submits multiple demands via the interface to  
the dispute resolution system and the dispute resolution system pairs the multiple  
demands with offers of settlement for the claim on a one-to-one basis, a comparison  
will be performed in accordance with a criteria and if the criteria is satisfied and the  
claimant is an initiator for the claim in the system, the claimant will be provided, via  
10 the interface, with either an indication that the criteria is satisfied and a payment  
amount which reflects a higher amount relative to a normal payment amount, because  
the claimant is the initiator.

45. A method of automated on-line dispute resolution comprising:  
15 maintaining an interface to the internet through which a claimant can  
submit demands for a claim to a dispute resolution system and receive indications  
therefrom such that, when the claimant submits multiple demands via the interface to  
the dispute resolution system and the dispute resolution system pairs the multiple  
demands with offers of settlement for the claim on a one-to-one basis, a comparison  
20 will be performed in accordance with a criteria and if the criteria is satisfied, will  
provide a positive indication, via the interface, and automatically initiate a transfer to  
the claimant of an amount calculated by the dispute resolution system as a settlement  
figure, perform a power round analysis of a demand and an offer in accordance with a  
power round criteria and, following the power round, the claimant will be provided  
25 with either a positive or negative indication, via the interface, as to whether or not the  
power round criteria is satisfied.

46. A method of operating a dispute resolution system comprising:  
receiving a plurality of values from each of a first and second party to a  
30 dispute, at least one of the plurality of values having been received via an internet  
connection;



matching, on a one for one basis, values from the first party and values from the second party to create a plurality of pairs without disclosing either the first party's values to the second party and the second party's values to the first party;

analyzing pairs in accordance with a preset formula such that if, when  
5 analyzed, a pair meets a specified criteria, the system will report to the first and second parties that a settlement is reached.

47. The method of claim 46 further comprising:  
when the specified criteria is met, calculating a settlement value using  
10 at least a part of the pair.

48. The method of claim 36 wherein the calculating comprises:  
determining a median value for the pair.

15 49. The method of claim 46 further comprising:  
allowing the first party to make a selection of the preset formula.

50. The method of claim 46 further comprising:  
prior to the receiving, requiring one of the first or second parties to  
20 make a selection of the preset formula; and  
requiring another of the first or second parties to agree to the selection.

51. The method of claim 46 further including:  
receiving a sponsor identification number for the dispute and case  
25 description information.

52. The method of claim 46 further including:  
receiving information representing a venue for the dispute.

30 53. The method of claim 46 further including:  
receiving information representing a court for the dispute.

54. A method comprising:  
aggregating a plurality of values into a group value;  
evaluating a pair of values for a claim in a round, one of the values in  
5 the pair being the group value;  
determining that the pair of values satisfies a settlement criteria; and  
communicating a settlement message if the settlement criteria is  
satisfied.
- 10 55. The method of claim 54 further including:  
aggregating monetary amounts submitted by a group as a single  
monetary submission; and  
using the single monetary submission as the other of the pair.
- 15 56. The method of claim 54 further including:  
designating an entity to be opted out of a negotiation.
57. The method of claim 54 wherein the plurality of values includes  
at least one value submitted each member of a group, the method further including:  
20 identifying, to an adversary of the group for the claim, each member of  
the group.
58. A method comprising:  
registering a first entity in an automated dispute resolution system with  
25 respect to a case involving a claim;  
following registration, receiving a case identifier and at least two  
monetary submissions from the first entity;  
associating at least one proposed settlement amount submitted by a  
second entity with respect to the claim with at least one of the at least two monetary  
30 submissions;

processing a proposed settlement amount and one of the at least two  
monetary submissions in accordance with a specified algorithm to obtain a result; and  
notifying the first entity that a settlement of the claim has been reached  
and of a payment amount, when the result meets a criteria agreed to by the first entity,  
5 without ever informing the first entity of the at least one proposed settlement amount.

59. The method of claim 58 further comprising:  
permanently discarding the at least one proposed settlement amount and  
the one of the at least two monetary submissions when the settlement has been  
10 reached.

60. The method of claim 58 further comprising:  
storing case related information for the settlement and the payment  
amount in the automated dispute resolution system for tabulation.  
15

61. A dispute settlement method comprising:  
receiving offers and demands with respect to a claim, each of the offers  
having been received via a password protected communication linkage and having an  
associated sequence number, and each of the demands having an associated sequence  
20 number;  
matching offers against demands based upon a correspondence between  
the sequence numbers;  
testing matched offers and demands against an algorithm;  
generating a result in response to a testing of an offer and a demand;  
25 and  
automatically reporting the result, without disclosing the offer or  
demand.

62. The method of claim 61 wherein, when the result is no  
30 settlement, the method further comprising:  
discarding the offer and the demand.

WO 00/08582

PCT/US99/17737

63. The method of claim 61 wherein, when the result is a settlement, the method further comprising:  
calculating a settlement amount according to a preestablished formula;  
5 and  
reporting the settlement amount.
64. The method of claim 61 further comprising:  
obtaining an agreement from a claimant to participate in an indirect  
10 settlement negotiation using an on-line dispute settlement system and, when the result indicates a settlement, to be legally bound to settle the claim for an amount specified by the on-line dispute settlement system.
65. The method of claim 61 further comprising:  
15 obtaining an agreement from a sponsor to participate in an indirect settlement negotiation;  
generating an exposure amount using an offer submitted by the sponsor;  
and  
informing the sponsor of the exposure amount.  
20
66. The method of claim 64 further comprising:  
generating a potential settlement gain amount using a demand; and  
informing the claimant of the settlement gain amount.
67. A method comprising:  
25 evaluating a plurality of paired values for a claim in a plurality of rounds;  
determining that none of the plurality of paired values satisfies a settlement criteria;  
30 performing a power round evaluation of values, one of the values having been submitted by a first entity with respect to the claim and another of the

values having been submitted by a second entity, adverse to the first entity with respect to the claim; and

communicating a settlement message if the power round evaluation indicates that a power round settlement criteria is satisfied.

5

68. The method of claim 67 further including:  
receiving an agreement from a party to perform the power round  
evaluation.

10

69. The method of claim 67 further including:  
determining that the power round evaluation of values should occur  
based upon a system parameter.

15

70. The method of claim 69 wherein the determining includes:  
identifying a first engaging party.

20

71. The method of claim 67 wherein the determining includes:  
determining that the power round evaluation of values should occur by  
analyzing a differential in at least one pair of the plurality of paired values against at  
least another of the plurality of paired values.

25

72. The method of claim 67 wherein the determining includes:  
determining that the power round evaluation of values should occur  
based upon a relationship between at least one pair of the plurality of paired values and  
achieved settlements.

30

73. The method of claim 67 further including:  
receiving an agreement from a party to an adjustment from a normal  
payment amount in return for performing the power round evaluation.

74. The method of claim 67 wherein the performing the power round evaluation includes:

determining that the two values satisfies a power round settlement criteria.

5

75. The method of claim 74 wherein the power round settlement criteria is the settlement criteria.

76. The method of claim 74 wherein the power round settlement criteria differs from the settlement criteria.

10

77. The method of claim 67 wherein the performing the power round evaluation includes:

determining whether any of the plurality of paired values satisfies a power round settlement criteria.

15

78. The method of claim 67 further including:  
aggregating a plurality of submissions into a group value; and  
using the group value as one of the values in a pair.

20

79. The method of claim 77 wherein the power round settlement criteria and the settlement criteria differ.

80. A method comprising:

receiving a first value from a first entity with respect to a claim in an automated dispute resolution system;

25

receiving a second value from a second entity with respect to the claim in the automated dispute resolution system;

determining, in the automated dispute resolution system, that a comparison of the first and second values does not satisfy a settlement criteria for the claim;

30

discarding at least one of the first and second values;  
 prompting, using a facilitator, at least one of the first and second  
 entities for submission of a new value using a generic statement that does not reveal  
 either of the first or second values; and  
 5 receiving the new value in the automated dispute resolution system.

81. A dispute settlement method comprising:

receiving a claim submitted by an initiator for a dispute resolution  
 negotiation;

10 subsequent to the receiving of the claim, receiving a first value from the  
 initiator and a first value from a second entity, adverse to the initiator for the claim, the  
 first value from the initiator and the first value from the second entity differing from  
 each other by a differential amount;

15 comparing the differential amount against a predetermined settlement  
 criteria;

determining that the predetermined settlement criteria is satisfied by the  
 differential amount;

calculating a settlement payment using the first values such that the  
 initiator receives a windfall benefit and;

20 informing the initiator and the second entity of the settlement payment.

82. The method of claim 81 wherein the calculating comprises:

25 if the first value from the initiator is less than the first value from the  
 second entity and the settlement payment will be paid from the second entity to the  
 initiator, establishing the settlement payment at a greater amount than a normal  
 payment amount.

83. The method of claim 82 wherein the normal payment amount is  
 between the first values.

30

84. The method of claim 82 wherein the normal payment amount is a median of the first values.

5 85. The method of claim 81 wherein the calculating includes:  
if the first value from the initiator is greater than the first value from the second entity and the settlement payment will be paid from the initiator to the second entity, establishing the settlement payment at a lesser amount than a normal payment amount.

10 86. The method of claim 85 wherein the normal payment amount is between the first values.

15 87. The method of claim 85 wherein the normal payment amount is a median of the first values.

88. The method of claim 81 wherein the calculating the settlement payment using the first values such that the initiator receives the windfall benefit includes:  
equating the settlement payment to the first value from the second  
20 entity.

89. The method of claim 81 wherein the first value from the initiator is one of a plurality of first values from the initiator and the first value from a second entity is one of a plurality of first values from the second entity, the method  
25 further comprising:  
prompting the initiator using a non-revealing encouraging statement from a facilitator.

90. A method comprising:  
30 settling a case by processing at least one demand submitted by a claimant and at least one corresponding offer submitted by a second entity for a claim



in accordance with a preselected criteria agreed to by the claimant and the second entity, the at least one demand and at least one corresponding offer being different from each other;

calculating a settlement payment of a specified value to be paid to the  
5 claimant to settle the case; and  
automatically initiating the settlement payment to the claimant.

91. The method of claim 90 wherein the providing includes:  
configuring data for receipt by a stored value device which, when  
10 received, will cause a stored value to be increased by the specified amount.

92. The method of claim 90 wherein the providing includes:  
crediting a payment card account, registered to the claimant, with the  
15 specified amount.

93. The method of claim 92 wherein the payment card account is at  
least one of a credit card, debit card, charge card, entertainment card account.

94. The method of claim 90 wherein the providing includes:  
20 initiating a wire transfer, in the specified amount, to an account of the  
claimant.

95. The method of claim 90 wherein the providing includes:  
electronically initiating an irrevocable transfer of property valued at the  
25 specified amount to the claimant.

96. The method of claim 90 wherein the providing includes:  
crediting an affinity program account registered to the claimant  
according to the specified amount.

30 97. The method of claim 90 wherein the providing includes:

electronically initiating an irrevocable transfer of an ownership interest to the claimant in the specified amount.

5 98. The method of claim 90 wherein the providing includes:  
electronically initiating issuance of an insurance product for the  
settlement amount.

99. A method of consummating an on-line dispute resolution  
negotiation comprising:  
10 determining that two non-equal values, submitted by adverse parties to  
a dispute, satisfies a claim settlement criteria in a round such that a payment will be  
made from one of the adverse parties to the other of the adverse parties; and  
automatically generating settlement documents for the dispute for the  
adverse parties.

15 100. The method of claim 99 wherein the generating further  
comprises:  
creating a settlement agreement identifying the adverse parties.

20 101. The method of claim 99 wherein the generating further  
comprises:  
creating a stipulation of dismissal.

25 102. The method of claim 101 further comprising:  
creating a case caption for inclusion in the stipulation of dismissal.

103. The method of claim 99 wherein the generating further  
comprises:  
creating a release.

30 104. A method comprising:

agreeing to a criteria which, when applied by a dispute resolution system to values and satisfied, will result in a settlement of a claim against a party for a payment amount specified by the dispute resolution system, the payment amount being derived from at least one of the values;

5 submitting a plurality of monetary values to the dispute resolution system, via a security protected on line interface, which will be analyzed by the dispute resolution system using the criteria without revealing any of the monetary values to the party;

receiving an indication that the criteria is satisfied by an unrevealed  
10 value from the party and at least one of the plurality of monetary values; and  
receiving a notification of the payment amount for the claim.

105. The method of claim 104 wherein, prior to receiving the indication, the method includes:

15 receiving a message that the criteria has not been satisfied for one unrevealed value for the party and one monetary value.

106. The method of claim 104 wherein the payment amount is at least one of the plurality of monetary values.

20

107. The method of claim 104 wherein the payment amount is greater than the at least one of the plurality of monetary values.

25

108. The method of claim 104 further including:  
logging in to the dispute resolution system through the internet.

109. The method of claim 104 further including:  
providing claim specific identification information.

30

110. The method of claim 104 further including:  
providing attorney contact information for the claim.

111. The method of claim 57 further including:  
tabulating the claim specific identification information.
- 5 112. The method of claim 104 further including:  
accessing the dispute resolution system using a web browser.
113. The method of claim 104 further including:  
submitting a plurality of cases to the dispute resolution system, the  
10 claim relating to one of the plurality of cases.
114. The method of claim 104 further including:  
paying the payment amount.
- 15 115. The method of claim 104 further including:  
receiving the payment amount from the party.
116. A method comprising steps, stored in an automated dispute  
resolution system including a processor and storage, for dispute resolution the method  
20 comprising:  
a step of executing a first program module, written in a markup  
language, for receiving values submitted by a party via the internet, the values  
representing a series of proposed amounts for which a claim would be settled;  
a step of executing a program object, written in an object oriented  
25 programming language, for sequentially comparing individual proposed amounts of  
the series of proposed amounts against individual proposed counter amounts of a series  
of proposed counter amounts, all of the proposed counter amounts being unavailable to  
the party, in order to determine if a difference between any of the sequentially  
compared individual proposed amounts and counter amounts is within a specified  
30 range and for generating a settlement indication if the difference is within the specified  
range; and

a step of executing a second program module for informing the party that the claim is settled by a payment of a calculated amount.

5           117. The method of claim 116 further including:  
a step for calculating a settlement amount according to a specified formula using an individual proposed amount as an input for the specified formula for specifying a payment to be made in settlement of the claim.

10           118. The method of claim 116 further including:  
a step for calculating a settlement amount according to a specified formula using an individual proposed counter amount as an input for the specified formula for specifying a payment to be made in settlement of the claim.

15           119. The method of claim 116 further including:  
a step for calculating a settlement amount according to a specified formula using both an individual proposed amount and an individual proposed counter amount as an input for the specified formula for specifying a payment to be made in settlement of the claim.

20           120. The method of claim 116 further including:  
a step for logging the party in.

25           121. The method of claim 116 further including:  
a step for collecting and processing settlement data using the processor.

30           122. The method of claim 116 further including:  
a step for checking administration authorization to enable an administrator to add a sponsor into the automated dispute resolution system.

30           123. A method comprising steps for multi-round dispute resolution, the method comprising:

a first step for analyzing pairs of values in normal rounds according to a first criteria, each of the pairs of values including one value provided by a first party and another value provided by a second party adverse to the first party with respect to a claim, the values in each pair of values differing in magnitude from each other;

5 a second step for determining if the first criteria is satisfied in a round;  
a third step for, when a the first criteria is not satisfied, determining if a power round analysis is necessary;

a fourth step for, when the power round analysis is necessary, analyzing a pair of values in accordance with a power round criteria; and

10 a fifth step for, when either the first criteria is satisfied or, the first criteria is not satisfied but the power round criteria is satisfied, generating a payment to be made on the claim.

124. The method of claim 123 further comprising:

15 a sixth step for constructing a claim specific facilitating message, for communication to at least one of the first and second parties, that does not reveal a value provided by the first party to the second party and vice-versa.

125. The method of claim 123 further comprising:

20 a step for adjusting the payment to provide a windfall benefit to either the first party, when the first party is an initiator for the claim, or the second party when the second party is the initiator for the claim.

126. The method of claim 123 further comprising:

25 a step for initiating an on-line transfer of funds equal to the payment from the whichever of the first or second party is a second entity for the claim to whichever of the first or second party is a claimant for the claim.

127. The method of claim 123 further comprising:

a step for on-line generation of documents including an identification of the claim, whichever of the first or second party is a claimant for the claim and the payment.

- 5           128. A method comprising:  
receiving a submission of a case from a sponsor;  
receiving an agreement to a criteria which, if satisfied, would result in a  
binding settlement of the case;  
generating a message for communication to a representative of a  
10 claimant involved in the case which invites the representative to participate in an  
automated dispute resolution negotiation for the case;  
receiving a responsive agreement from the representative to participate  
and to be bound by the automated dispute resolution negotiation, if the criteria is  
satisfied by demands submitted by the representative and correlated offers submitted  
15 by the sponsor;  
receiving a demand submitted by the representative and an offer  
submitted by the sponsor, within a specified limited time period;  
comparing the demand and the offer to determine if the criteria is  
satisfied; and  
20 if the criteria is satisfied, generating an indication that the case is settled  
for a payment amount.

129. The method of claim 128 further comprising:  
requiring entry of a dispute identification number prior to receiving the  
25 demand and the offer.

130. The method of claim 128 further comprising:  
storing the payment amount for future retrieval.

- 30 131. The method of claim 128 further comprising:  
calculating the payment amount as a median of demand and the offer.

132. The method of claim 128 further comprising:  
calculating the payment amount as a value between the demand and the  
offer.

5

133. A method comprising:  
receiving first signals including data representing a series of monetary  
amounts for a claim from a first entity;  
preparing the first signals for automated testing against an algorithm by  
10 a dispute resolution system in conjunction with information from a second entity, the  
second entity being adverse to the first entity with respect to the claim;  
receiving a response signal indicating that a test of one of the series of  
monetary amounts caused a settlement condition in the dispute resolution system;  
forwarding a message including data representing a settlement amount,  
15 in response to the settlement condition, for ultimate delivery to the first entity.

134. The method of claim 133 further including:  
receiving second signals including the information from the second  
entity, the information having data representing at least one proposed settlement  
20 amount for the claim.

135. The method of claim 133 wherein the first entity is one of a  
claimant, a representative of a claimant, or an attorney for the claimant.

25 136. The method of claim 135 wherein the second entity is one of an  
insurer, a claims adjuster, an attorney for an insurer, a sponsor, a sponsor  
administrator, a system administrator, or an agent of a self-insured organization.

30 137. The method of claim 133 wherein the first entity is one of an  
insurer, a claims adjuster, an attorney for an insurer, a sponsor, a sponsor  
administrator, a system administrator, or an agent of a self-insured organization.



138. The method of claim 133 further including:  
forwarding cookie data sent by the dispute resolution system for storage  
on a hard drive associated with either the first or second entity usable by the dispute  
5 resolution system to track usage by the first or second entity.

139. The method of claim 138 further including:  
receiving third signals from the dispute resolution system for  
forwarding to a computer associated with either the first or the second entity which,  
10 when received, would cause the computer to retrieve the cookie data from the hard  
drive and send it to the dispute resolution system.

140. A method comprising:  
a) receiving first signals over a communications linkage from an  
15 insurer, the signals including data communicated for temporary storage, the data  
representing two values usable as offers to settle a claim, one of the two values being  
greater than the other of the two values;  
b) sending a request to a claimant to submit demands representing  
different monetary amounts for which the claimant would settle the claim, without  
20 revealing any of the offers to the claimant;  
c) receiving second signals representing a response from the  
claimant, the signals including a monetary demand;  
d) comparing the monetary demand with a first of the offers and, if  
the comparison is within specified guidelines, informing the claimant, via transmitted  
25 information displayable on a web browser, that the claim will be settled for a specified  
amount that is calculated using at least the demand, otherwise, prompting the claimant  
to submit a new demand.

141. The method of claim 140 further comprising:  
30 if the comparison is within specified guidelines, informing the insurer  
by mail that the claim will be settled for the specified amount.

142. The method of claim 140 further comprising:  
prior to receiving the first signals, providing access to tabulated  
information from a plurality of settled cases.

5

143. The method of claim 140 further comprising:  
tabulating case specific information from a plurality of settled cases for  
which specified amounts were calculated, so that the case specific information is  
accessible according to categories.

10

144. The method of claim 143 wherein the categories include at least  
one of:  
a court, a venue, an attorney, a settlement payment amount, and a  
sponsor.

15

145. A method of automated on-line dispute resolution comprising:  
maintaining an interface to the internet through which a claimant can  
submit demands for a claim to a dispute resolution system and receive indications  
therefrom such that, when the claimant submits multiple demands via the interface to  
the dispute resolution system and the dispute resolution system pairs the multiple  
demands with offers of settlement for the claim on a one-to-one basis, a comparison  
will be performed in accordance with a criteria and the claimant will be provided with  
either a positive or negative indication, via the interface, as to whether or not the  
criteria is satisfied for a pair.

25

146. The method of claim 145 further comprising:  
forwarding received information, via the interface, for display to the  
claimant including a settlement value supplied by the dispute resolution system  
calculated when the criteria is satisfied.

30

147. The method of claim 145 further comprising:

hosting the dispute resolution system.

148. The method of claim 145 further comprising:

storing a processor executable program which, when executed,  
5 performs the comparison and provides the claimant with the either positive or negative  
indication for the claim.

149. A system comprising:

a first value, submitted on line by a first entity;  
10 a second value submitted on line by a second entity, the first and second  
entities being adverse to each other with respect to a claim, the first value being  
inaccessible to the second entity and the second value being inaccessible to the first  
entity, the first value and the second value being different in magnitude from each  
other;  
15 a proxy including an input, an output and a computer executable  
program, the program being structured to, when executing, accept a pair of values from  
adverse entities via the input and return a result indicator to the proxy based upon a  
mathematical comparison of the pair of values, the program being further structured to  
provide a payment value for the claim to at least one of the adverse entities via the  
20 output when the result indicator indicates that a predetermined criteria is satisfied.

150. The system of claim 149 further including processor accessible  
storage configured to temporarily store the first and second values for retrieval by the  
proxy via the input.

25

151. The system of claim 149 wherein the computer executable  
program includes a plurality of modules, one of which is programmed in an object  
oriented programming language and another of which is programmed in a markup  
language.

30

152. The system of claim 151 wherein the object oriented programming language includes JavaScript.

153. The system of claim 151 wherein the markup language is  
5 ColdFusion Markup Language.

154. The system of claim 151 wherein the markup language is Hyper Text Markup Language (HTML).

10 155. The system of claim 149 wherein, when the program is executed and the result indicator indicates that the predetermined criteria is not satisfied, the proxy discards the pair of values.

15 156. The system of claim 149 wherein, when the program is executed and the result indicator indicates that the predetermined criteria is satisfied, the proxy calculates the payment value from the pair of values and then discards the pair of values.

20 157. The system of claim 149 wherein the first value is an offer made by a sponsor and the second value is a demand made by a claimant.

158. The system of claim 149 further including an entity accessible detail log including a correlation of payment values and claim specific information.

25 159. The system of claim 158 wherein the claim specific information includes data indicative of a geographic area.

30 160. The system of claim 158 further including proxy accessible storage into which the proxy can store the payment value and data representing claim specific information when the result indicator indicates that the predetermined criteria is satisfied.

161. The system of claim 149 wherein the pair of values is the first and second values, the predetermined criteria is satisfied and the payment value is the median of the first and second values.

5

162. The system of claim 149 wherein the pair of values is the first and second values, the predetermined criteria is satisfied and the payment value is the greater of the first and second values.

10

163. The system of claim 149 wherein the predetermined criteria is that the pair of values must be within a fixed percentage of each other.

15

164. The system of claim 163 further including a predetermined override amount which will be compared to a differential between the pair of values if the result indicator indicates that the predetermined criteria is not satisfied and, if the differential is less than the predetermined override amount, will cause the proxy to provide the payment value for the claim to at least one adverse entity even though the predetermined criteria was not satisfied.

20

165. The system of claim 163 wherein the pair of values is the first and second values, the predetermined criteria is satisfied and the payment value is the median of the first and second values.

25

166. The system of claim 163 wherein the pair of values is the first and second values, the predetermined criteria is satisfied and the payment value is the greater of the first and second values.

30

167. The system of claim 163 wherein the pair of values is the first and second values, the predetermined criteria is satisfied and the payment value is a function of the first and second values.

168. The system of claim 149 wherein the predetermined criteria is a fixed spread value.

169. The system of claim 149 wherein the payment value is of a magnitude between one of the values in the pair of values and another of the values in the pair of values.

170. The system of claim 150 further including a time indicator which, when exceeded, will cause the proxy to take a predetermined action with regard to at least one of the first or second values.

171. The system of claim 170 wherein, the predetermined action is a discarding of the at least one of the first or second values.

172. The system of claim 170 wherein the first and second values are withdrawable and the predetermined action prevents a withdrawal of one of the first or second values.

173. The system of claim 150 further including an entity accessible detail log including a correlation of payment values and claim specific information.

174. The system of claim 173 wherein the entity accessible detail log is written in a markup language.

175. The system of claim 149 further including an exposure calculator.

176. The system of claim 175 wherein the exposure calculator is written in an object oriented programming language.

177. The system of claim 176 wherein the object oriented programming language includes JavaScript.

178. The system of claim 149 wherein the first value is one of a plurality of sequentially submitted first values and the second value is one of a plurality of sequentially submitted second values, all of the sequentially submitted values being inaccessible to the entity that did not submit them, and wherein the program is further structured to utilize another of the plurality of sequentially submitted first values, specified by the first entity, in place of the first value and another of the plurality of sequentially submitted second values, specified by the second entity, in place of the second value when the result indicator indicates that the predetermined criteria is not satisfied for the first and second values.

179. The system of claim 178 wherein each of the plurality of first values is submitted by the first entity according to a specified order.

180. The system of claim 149 further including a program execution limit.

181. The system of claim 180 wherein the program execution limit is three.

182. The system of claim 169 wherein the plurality of first values submitted by the first entity is two.

183. The system of claim 149 further including a payment calculator which, when the predetermined criteria has been satisfied, will calculate, in accordance with a formula, a monetary amount to be paid by one entity to the other to settle the claim.

184. The system of claim 183 wherein the formula is a median of the pair of values which caused the predetermined criteria to be satisfied.

185. The system of claim 183 wherein the formula is the greater of  
5 the pair of values which caused the predetermined criteria to be satisfied.

186. The system of claim 178 further including an entity searchable database including data relating to settled claims.

10 187. The system of claim 186 wherein the data includes geographic information for each settled claim.

188. The system of claim 186 wherein the data includes a monetary amount for each settled claim.

15 189. The system of claim 186 wherein the system further includes a communication link over which the entity searchable database can be accessed by an entity prior to submitting an offer or a demand.

20 190. The system of claim 178 wherein the first plurality of values are demands from a claimant.

191. The system of claim 178 wherein the first plurality of values are offers from an insurer.

25 192. The system of claim 149 wherein the first value is one of a plurality of sequentially submitted first values and the second value is one of a plurality of sequentially submitted second values, all of the sequentially submitted values being inaccessible to the entity that did not submit them, and wherein an  
30 acceptance of a pair of values by the program along with the returning of the result indicator constitutes a round.



193. A system comprising:  
a first value, submitted on line by a first entity;  
a second value submitted on line by a second entity, the first and second  
5 entities being adverse to each other with respect to a claim, the first value being  
inaccessible to the second entity and the second value being inaccessible to the first  
entity, the first value and the second value being different in magnitude from each  
other;  
an input connectable to an on-line interface for receipt of values  
10 therefrom;  
an output;  
memory connected to the input and configured to receive and  
temporarily store values received from the input;  
a processor connected to the memory; and  
15 a computer executable program, the program being structured to, when  
executed by the processor, accept a pair of values from adverse entities and return a  
specified result indicator based upon the application of a predetermined criteria to a  
mathematical comparison of the pair of values in a normal round and, when the result  
indicator indicates that the predetermined criteria is not satisfied in the normal round,  
20 the program being further structured to perform a power round analysis of a power  
round pair of values by applying a predetermined power round criteria to the power  
round pair of values and, when a power round result indicator indicates that the  
predetermined power round criteria is satisfied, provide a power round payment value  
for the claim to at least one of the adverse entities via the output.

25

194. The system of claim 193 wherein one of the power round pair of  
values is the same as one of the pair of values.

195. The system of claim 193 wherein the predetermined criteria and  
30 the predetermined power round criteria are different.

196. The system of claim 193 wherein the predetermined criteria and the predetermined power round criteria are the same.

197. A system comprising:

- 5 a facilitator including a plurality of non-revealing entity prompts;  
a first value, submitted on line by a first entity;  
a second value submitted on line by a second entity, the first and second entities being adverse to each other with respect to a claim, the first value being inaccessible to the second entity and the second value being inaccessible to the first  
10 entity, the first value and the second value being different in magnitude from each other, at least one of the first value and the second value having been submitted following a communication from the facilitator to either the first entity or the second entity of an entity prompt of the plurality of entity prompts, the entity prompt further being a non-revealing entity prompt; and  
15 a proxy including an input, an output and a computer executable program, the program being structured to, when executing, accept a pair of values from adverse entities via the input and return a result indicator to the proxy based upon the application of a predetermined criteria to a mathematical comparison of the pair of values, the program being further structured to provide a payment value for the claim  
20 to at least one of the adverse entities via the output when the result indicator indicates that the predetermined criteria is satisfied.

198. A system comprising:

- 25 an initiator indicator, settable when an entity first enters a dispute for resolution into the system to identify the entity as an initiator which, when set for the dispute, will cause a windfall adjustment calculation to be performed;  
a first value, submitted on line by a first entity;  
a second value submitted on line by a second entity, the first and second entities being adverse to each other with respect to a claim, the first value being  
30 inaccessible to the second entity and the second value being inaccessible to the first

entity, the first value and the second value being different in magnitude from each other; and

a proxy including an input, an output and a computer executable program, the program being structured to, when executing, accept a pair of values from adverse entities via the input and return a result indicator to the proxy based upon the  
 5 application of a predetermined criteria to a mathematical comparison of the pair of values, the program being further structured to provide to at least one of the adverse entities, via the output when the result indicator indicates that the predetermined criteria is satisfied, either:

- 10                   i) a normal payment amount for the claim, when the initiator indicator is not set for either the first entity or the second entity, or  
                       ii) a windfall benefit adjusted payment amount for the claim, when the initiator indicator is set for one of the first entity or second entity.

15                   199. The system of claim 198 wherein the windfall adjusted payment amount for the pair of values is greater than the payment amount for the pair of values.

200. The system of claim 198 wherein the windfall adjusted payment amount for the pair of values is less than the payment amount for the pair of values.

20                   201. A claim dispute resolution system comprising:  
                       at least one demand submitted by a claimant for a claim and at least one corresponding offer submitted by a second entity for the claim;  
                       a preselected criteria, agreed to by the claimant and the second entity,  
 25 which will be applied, during analysis of the at least one demand and the at least one corresponding offer, to determine if there is a resolution for the claim;  
                       a claim dispute resolution program constructed to, when executing on a programmed processor, cause an analysis of numbers in accordance with criteria and calculate claim settlement payments when the criteria is satisfied; and  
 30 a programmed processor executing the claim dispute resolution program, to analyze the at least one demand and at least one corresponding offer in accordance with the

preselected criteria and, when the preselected criteria is satisfied, calculate a settlement payment of a specified value to be paid to the claimant to settle the claim and set the settlement initiation indicator thereby automatically initiating a payment to the claimant.

5

202. A dispute resolution application stored on a computer accessible storage media for execution by a processor comprising:

a plurality of modules which, when executed by the processor:

10 accepts and compares paired monetary values submitted by two entities adverse to each other with respect to a claim,

discards the paired monetary values which differ from each other by more than a specified range,

15 calculates a settlement amount to be paid by one entity to another entity if a pair of the monetary values differ from each other within the specified range based upon the pair and then discards the pair, and

provides the settlement amount for delivery to the two entities.

203. A method of automated dispute resolution in a system with at least one central processing unit comprising:

20 (a) introducing into the central processing unit, information corresponding to a series of rounds of demands to satisfy a claim received from a first party for a dispute without disclosure of the demands to any parties adverse to the first party in the dispute;

25 (b) introducing into the central processing unit, information corresponding to a series of rounds of offers to settle the claim received from a second party, adverse to the first party, for the dispute without disclosure of the offers to any parties adverse to the second party in the dispute;

(c) steps (a) and (b) occurring in any order;

30 (d) comparing the information corresponding to the series of demands and the series of offers on a round-by-round basis in accordance with preestablished conditions;

(e) determining, using the central processing unit, if a settlement of the dispute is caused by a demand and an offer in a round by meeting the preestablished conditions;

(f) if the demand and the offer in the round causes the settlement,  
5 calculating a settlement payment equal to one of:

(i) a first amount, calculated in accordance with a first preestablished formula, if the offer in the round is less than the demand and within a preestablished percentage of the demand in the same round, or

(ii) the demand, if the offer in the round is the same as or  
10 greater than the demand, or

(iii) a second amount, calculated in accordance with a second preestablished formula, if the offer is not within the preestablished percentage of the demand in all rounds but the difference between a particular offer and a corresponding demand is less than a preestablished amount;

(g) permanently deleting the series of demands and the series of offers when either none of the series of demands and series of offers meet the preestablished conditions or the settlement payment has been calculated; and

(h) communicating either a failure to settle message, when none of the series of demands and series of offers meet the preestablished conditions and every  
20 difference between unsuccessful offers and a corresponding demand is greater than a preestablished amount, or a settlement message including the settlement payment, when the preestablished conditions are met or the offer is not within the preestablished percentage of the demand in all rounds but the difference between the particular offer and the corresponding demand is less than the preestablished amount.

25

204. A system for automated dispute resolution comprising:

a processor for processing demands and offers;

means for introducing to the processor, via a communications linkage, information identifying a dispute, a series of demands to satisfy a claim made by or on  
30 behalf of a person involved in the dispute, and a series of offers to settle the claim by an entity adverse to the person for the claim;

memory means, accessible by the processor, for storing the information identifying the dispute and for temporarily storing the series of demands to satisfy the claim and the series of offers to settle the claim for use by the processor in a series of rounds without disclosure of the series of demands to the adverse entity or series of offers to the person;

comparison means, in communicating relationship with the processor, for receiving and comparing one of the series of demands and one of the series of offers, against each other on a round-by-round basis, in accordance with preestablished conditions until either all of the series of demands and series of offers have been exhausted or a settlement is indicated for a demand and an offer in a round, such that, if the settlement is indicated the claim is settled for:

(a) an amount, in accordance with a first preestablished formula, if the offer in the round in which the preestablished condition is met is less than the demand and within a preestablished percentage of the demand in the round,

(b) the demand, if the offer in any round is the same as or greater than the demand, and

(c) an amount in accordance with a second preestablished formula, if the offer is not within the preestablished condition in all rounds but the difference between a particular offer and a corresponding demand is less than a preestablished amount,

means for permanently inhibiting a reuse of an unsuccessful demand, or unsuccessful offer, by the comparison means in a subsequent round; and

means for communicating a result of the comparison to the person and the entity.

25

205. The system of claim 204 further comprising means for accessing actual settlements from other disputes.

206. The system of claim 204 wherein the communication linkage is an internet connection.

30

207. The system of claim 204 wherein the communication linkage is a voice connection.

208. The system of claim 204 wherein the series of offers to settle the claim comprise three settlement offers.

209. The system of claim 204 further comprising:  
means for generating voice messages through a telephone linkage for guiding a user in a use of the system.

10

210. The system of claim 204 further comprising:  
security means for preventing an access of the system until provision to the system of at least one of:

15

- a) a case identification number identifying the dispute,
- b) a security code corresponding to the dispute, or
- c) an administrator code for the person or the entity.

20

211. The system of claim 204 further comprising  
time keeping means for associating an entry time with at least a first of the series of demands to satisfy the claim and at least a first of the series of offers to settle the claim.

25

212. The system of claim 204 wherein all of the series of demands and the series of offers are received by the system at different times.

30

213. A system for automated dispute resolution comprising:  
processor means for processing demands and offers;  
means for introducing to the processor means, via a communications linkage, information identifying a dispute, a series of demands to satisfy a claim made by or on behalf of a person involved in the dispute, and a series of offers to settle the claim by an entity adverse to the person for the claim;

settable means for indicating whether or not to perform a power round comparison;

memory means, accessible by the processor means, for storing the information identifying the dispute, and for temporarily storing the series of demands to satisfy the claim and the series of offers to settle the claim, for use by the processor means in a series of rounds, without disclosure of the series of demands to the adverse entity or series of offers to the person;

settlement means for indicating, when set, settlements of disputes and calculating settlement values as a result thereof such that, when the settlement means is set for a round, the settlement means will calculate a settlement value equal to:

(a) a first amount, in accordance with a first preestablished formula, if the offer in the round is less than the demand and within a preestablished percentage of the demand in the round,

(b) the demand, if the offer in any round is the same as or greater than the demand, and

(c) a second amount in accordance with a second preestablished formula, if the offer is not within the preestablished condition in all rounds but the difference between a particular offer and a corresponding demand is less than a preestablished amount;

comparison means within the processor means, for receiving and comparing demands and offers against each other on a round-by-round basis, in accordance with a preestablished condition, and a power round comparison only when the settable means is set, in accordance with a power round condition, the comparison means setting the settlement means when either the preestablished condition or the power round condition is satisfied, the comparison means operating on the series of demands and series of offers until;

i) the settlement means is set, irrespective of whether the settable means is set,

ii) all of the series of demands and series of offers have been exhausted and the settable means is set, wherein the comparison means will perform a power round comparison of a power round demand with a power round offer



against each other in accordance with a preestablished power round condition and set the settlement means to indicate a settlement if the power round condition is satisfied, or

5                   iii)    all of the series of demands and series of offers have been exhausted and either the settable means is not set or the power round condition is not satisfied, wherein the comparison means will set the settable means to indicate no settlement;

                  means for inhibiting a reuse of an unsuccessful demand, or unsuccessful offer, by the comparison means in any round that is not a power round; and  
10                   means for communicating a settlement result to the person and the entity.

214.   The system of claim 213 further comprising:  
          facilitator means, constrained by a plurality of rules, for prompting, in  
15 accordance with the rules, at least one of the person or the entity prior to introducing one of the series of demands or series of offers into the processor means.

215.   The system of claim 213 further comprising:  
          means for determining whether one of the person or the entity is an  
20 initiator.

216.   The system of claim 214. further comprising:  
          means for adjusting the first amount, the demand and the second amount by a windfall differential when one of the person or the entity is the initiator.  
25

217.   The system of claim 213 further comprising:  
          means for on-line initiation of a transfer of the settlement value in accordance with a preference indicated by one of the person or the entity.

30                   218.   The system of claim 213 further comprising:

means for generating on-line a settlement document including at least some of the dispute identifying information.

219. A system for automated dispute resolution comprising:

5

processor means for processing demands and offers;

means for introducing to the processor means, via a communications linkage, information identifying a dispute, a series of demands to satisfy a claim made by or on behalf of a person involved in the dispute, and a series of offers to settle the claim by an entity adverse to the person for the claim;

10

memory means, accessible by the processor means, for storing the information identifying the dispute, and for temporarily storing the series of demands to satisfy the claim and the series of offers to settle the claim, for use by the processor means in a series of rounds, without disclosure of the series of demands to the adverse entity or series of offers to the person;

15

settlement means for indicating, when set, settlements of disputes and calculating settlement values as a result thereof;

20

facilitator means, constrained by a plurality of rules, for prompting, in accordance with the rules, at least one of the person or the entity prior to introducing one of the series of demands or series of offers into the processor means using non-revealing statements;

25

comparison means within the processor means, for receiving and comparing demands and offers against each other on a round-by-round basis, in accordance with a preestablished condition and for setting the settlement means when the preestablished condition is satisfied;

means for inhibiting a reuse of an unsuccessful demand, or unsuccessful offer, by the comparison means in any round that is not a power round; and

means for communicating a settlement result to the person and the entity.

30

220. A system for automated dispute resolution comprising:

processor means for processing demands and offers;

means for introducing to the processor means, via a communications linkage, information identifying a dispute, a series of demands to satisfy a claim made by or on behalf of a person involved in the dispute, and a series of offers to settle the claim by an entity adverse to the person for the claim;

5 initiator means for indicating, when set, that there is an initiator of entry of the dispute into the system and for identifying the initiator;

memory means, accessible by the processor means, for storing the information identifying the dispute, and for temporarily storing the series of demands to satisfy the claim and the series of offers to settle the claim, for use by the processor means in a series of rounds, without disclosure of the series of demands to the adverse entity or series of offers to the person;

settlement means for indicating, when set, settlements of disputes;  
means for calculating a windfall adjusted settlement value when both the settlement means and the initiator means are set, and for calculating normal payment values when the settlement means is set and the initiator means is not set;

15 comparison means within the processor means, for receiving and comparing demands and offers against each other on a round-by-round basis, in accordance with a preestablished condition and for setting the settlement means when the preestablished condition is satisfied;

20 means for inhibiting a reuse of an unsuccessful demand, or unsuccessful offer, by the comparison means in any round that is not a power round; and

means for communicating a settlement result to the person and the entity.

25 221. A system for automated dispute resolution comprising:  
processor means for processing demands and offers;

means for introducing to the processor means, via a communications linkage, information identifying a dispute, a series of demands to satisfy a claim made by or on behalf of a person involved in the dispute, and a series of offers to settle the claim by an entity adverse to the person for the claim;

30

memory means, accessible by the processor means, for storing the information identifying the dispute, and for temporarily storing the series of demands to satisfy the claim and the series of offers to settle the claim, for use by the processor means in a series of rounds, without disclosure of the series of demands to the adverse  
5 entity or series of offers to the person;

settlement means for indicating, when set, settlements of disputes and calculating a settlement value for the dispute when set;

comparison means within the processor means, for receiving and comparing demands and offers against each other on a round-by-round basis, in  
10 accordance with a preestablished condition and for setting the settlement means when the preestablished condition is satisfied;

means for automatic on-line initiation of a transfer of the settlement value from the entity to the person in accordance with a preference indicated by one of the person or the entity;

15 means for inhibiting a reuse of an unsuccessful demand, or unsuccessful offer, by the comparison means in any other round; and

means for communicating a settlement result to the person and the entity.

20 222. The system of claim 221 further comprising:

means for on-line generation of a settlement document including at least some of the dispute identifying information.

223. A method for communicating and processing a series of  
25 demands to satisfy a claim made by or on behalf of a person involved in a dispute with at least one other person and a series of offers to settle the claim through a computerized system for automated dispute resolution having at least one central processing unit including operating system software for controlling the central processing unit, means for introducing information into the central processing unit  
30 corresponding to the identification of the dispute and the persons involved in the dispute and memory means for storing the information corresponding to the

identification of the dispute and the persons involved in the dispute, wherein the method comprises the steps of:

- (a) introducing into the central processing unit information corresponding to a series of rounds of demands to satisfy the claim from a party
- 5 representing a claimant involved in the dispute without disclosure of the demands to other persons involved in the dispute;
- (b) introducing into the central processing unit information corresponding to a series of rounds of offers to settle the claim from a party representing a person involved in the dispute against whom the claim is made without
- 10 disclosure of the offers to other persons involved in the dispute;
- (c) steps (a) and (b) occurring in any order;
- (d) comparing the information corresponding to the series of demands and the series of offers on a round-by-round basis in accordance with preestablished conditions including (i) that the claim is settled for an amount in
- 15 accordance with a first preestablished formula if the offer in any round is less than the demand and within a preestablished percentage of the demand in the same round; (ii) that the claim is settled for the demand amount if the offer in any round is the same as or greater than the demand; and (iii) that the claim is not settled if the offer is not
- 20 within the preestablished percentage of the demand in all rounds unless the difference between the offer and demand is less than a preestablished amount in which case the claim is settled for an amount in accordance with a second preestablished formula;

(e) permanently deleting the demand and the offer in each round that does not result in a settlement based upon said preestablished conditions upon comparison of the demand and the offer in said round; and

5 (f) communicating to the claimant and the person against whom the claim is made or representatives thereof the results of the comparison.

224. A dispute resolution method comprising:

establishing a first tier amount below which a first dispute resolution criteria will apply and above which a second dispute resolution criteria will apply;

10 analyzing non-equal values submitted for a claim by adverse parties in rounds such that, in a round:

a) if the values all fall below the first tier amount, a first tier settlement will occur when the first resolution criteria is satisfied and a first tier payment amount will be calculated,

15 b) if the values are all above the first tier amount, a second tier settlement will occur when the second resolution criteria is satisfied and a second tier payment amount will be calculated, and

c) if at least one of the values is below the first tier amount and at least another of values is above the first tier amount and at least one of the first or  
20 second resolution criteria is satisfied, the case will settle for a settlement amount no greater than a maximum exposure amount calculated using a value from the round, even if a median of the values in the round is greater than the maximum exposure amount; and

25 sending a notification identifying a case resolution payment amount equal to one of the first tier payment amount, the second tier payment amount or the settlement amount.

225. The method of claim 224 further including:

30 establishing a second tier amount below which the second dispute resolution criteria will apply and above which a third dispute resolution criteria will apply.

226. A method comprising:

establishing a plurality of ranges within each of which a settlement criteria will  
apply;

5 analyzing values submitted by adverse parties for a claim in rounds in  
accordance with the range into which each value falls;

if a result of the analyzing in a round is a settlement, calculating a settlement  
amount for the claim such less than a maximum exposure amount; and

generating a settlement message for the claim.

10

227. The method of claim 226 further including:

apportioning the settlement amount among a plurality of entities.

228. The method of claim 226 further including:

15 aggregating a plurality of submissions from a plurality of entities into a value.

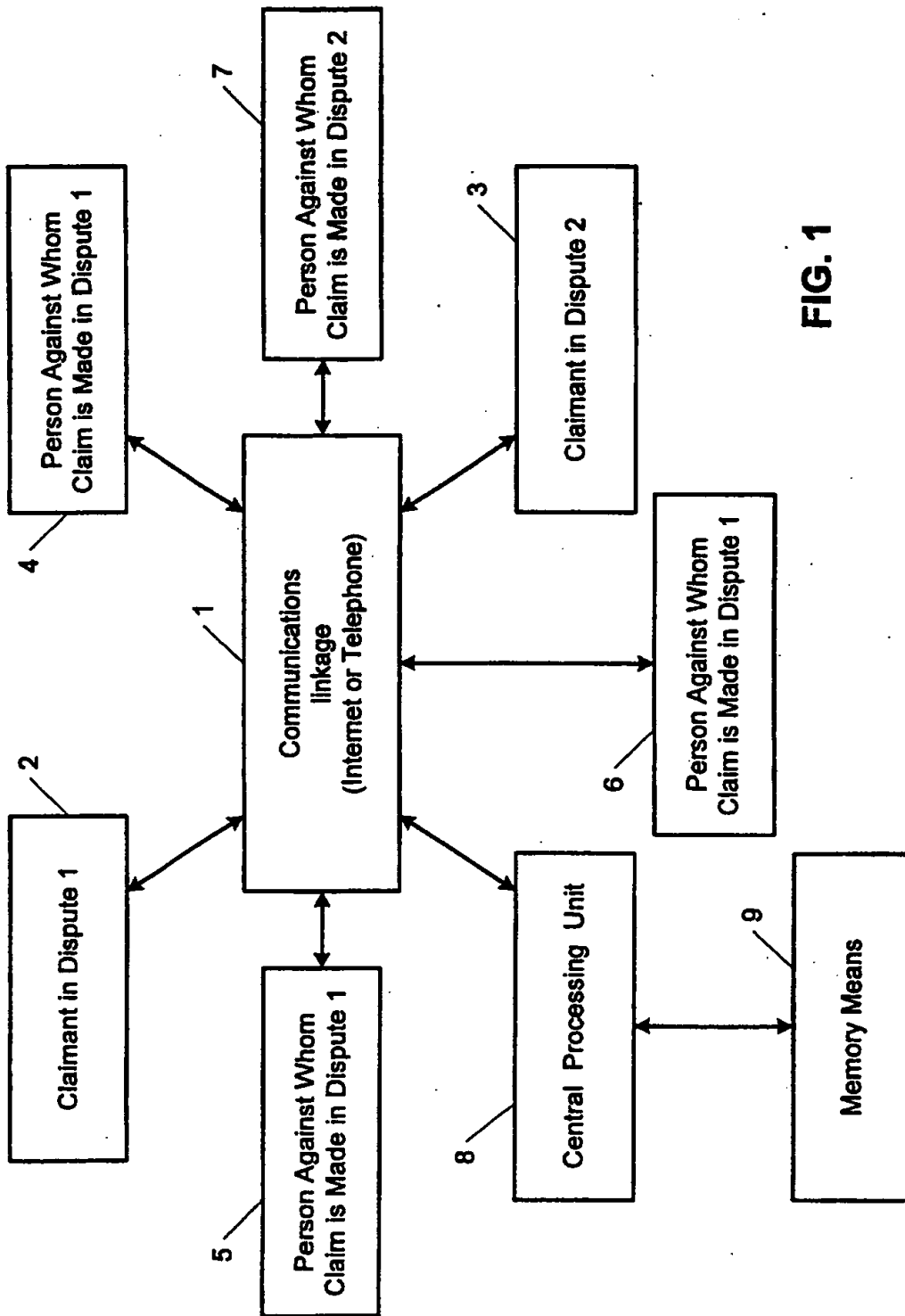

FIG. 1



27

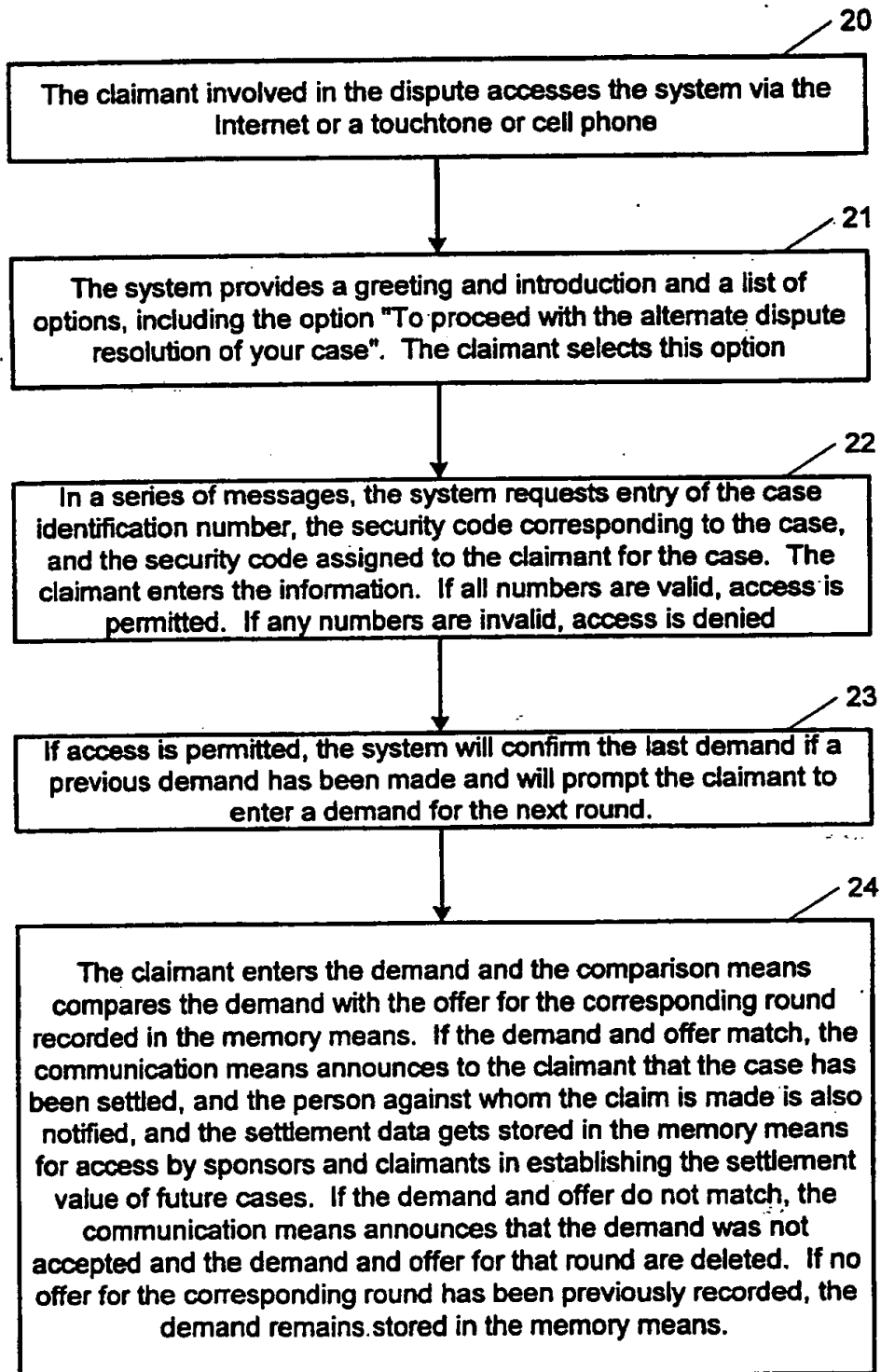

FIG. 2

3/7

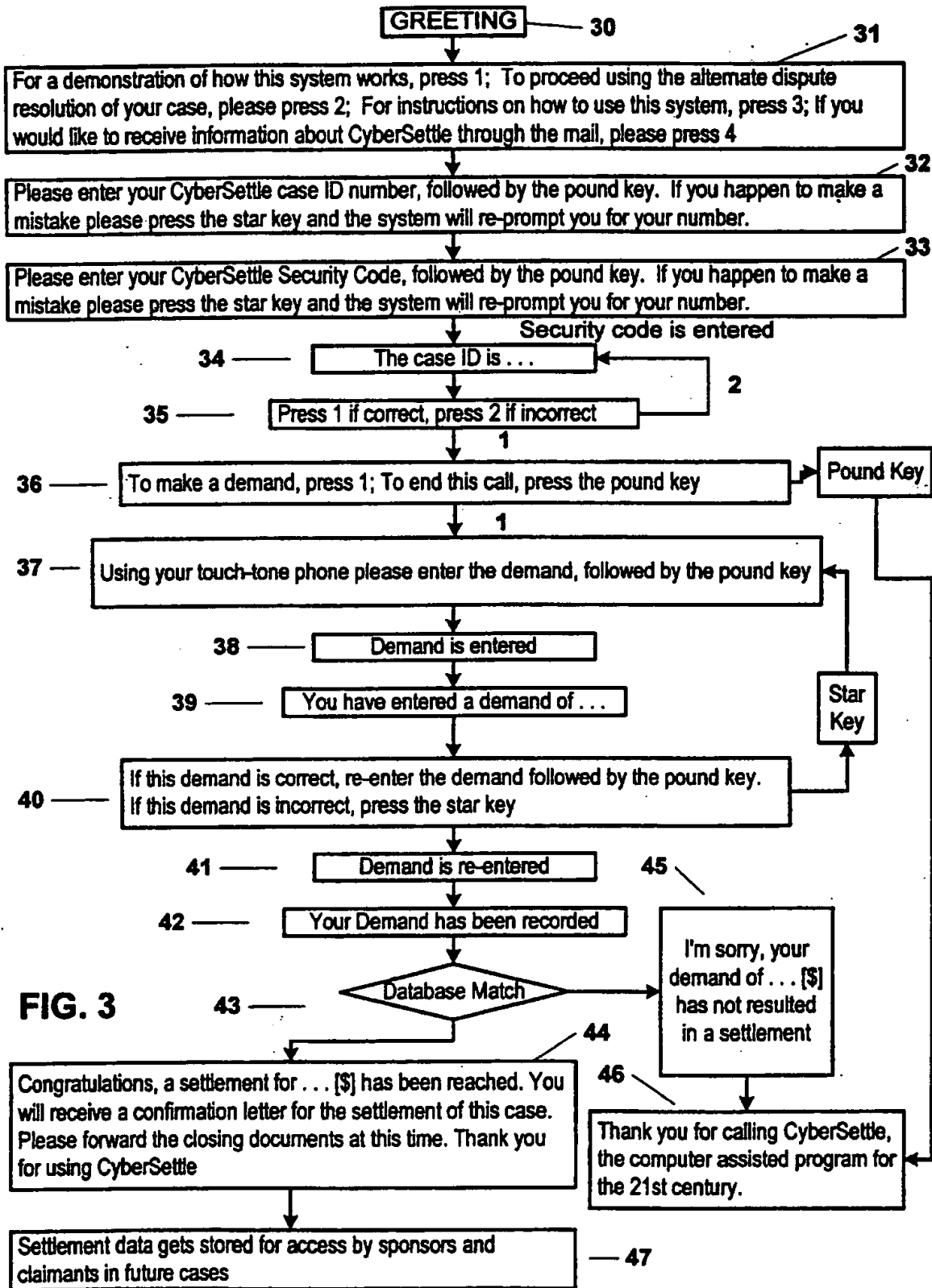

FIG. 3

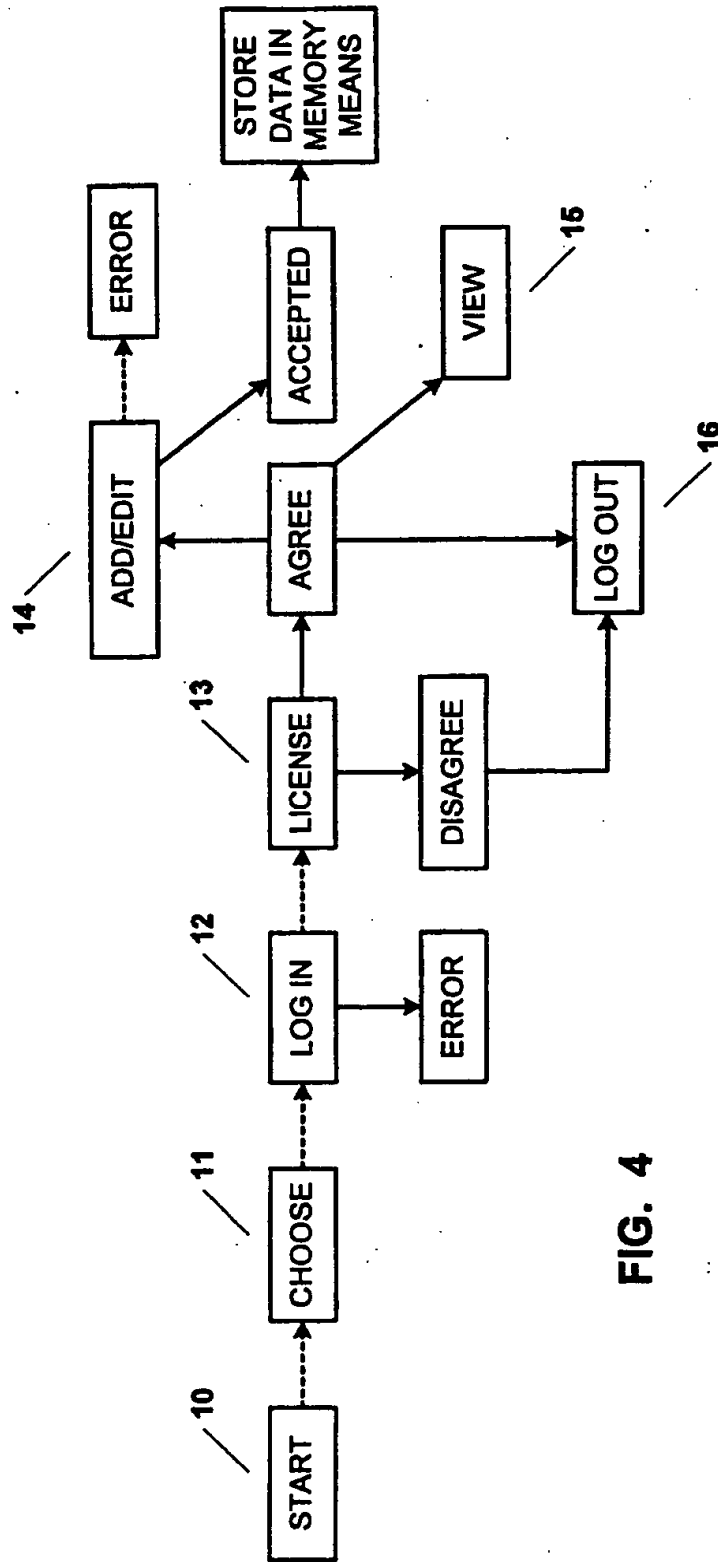

FIG. 4

FIG. 5

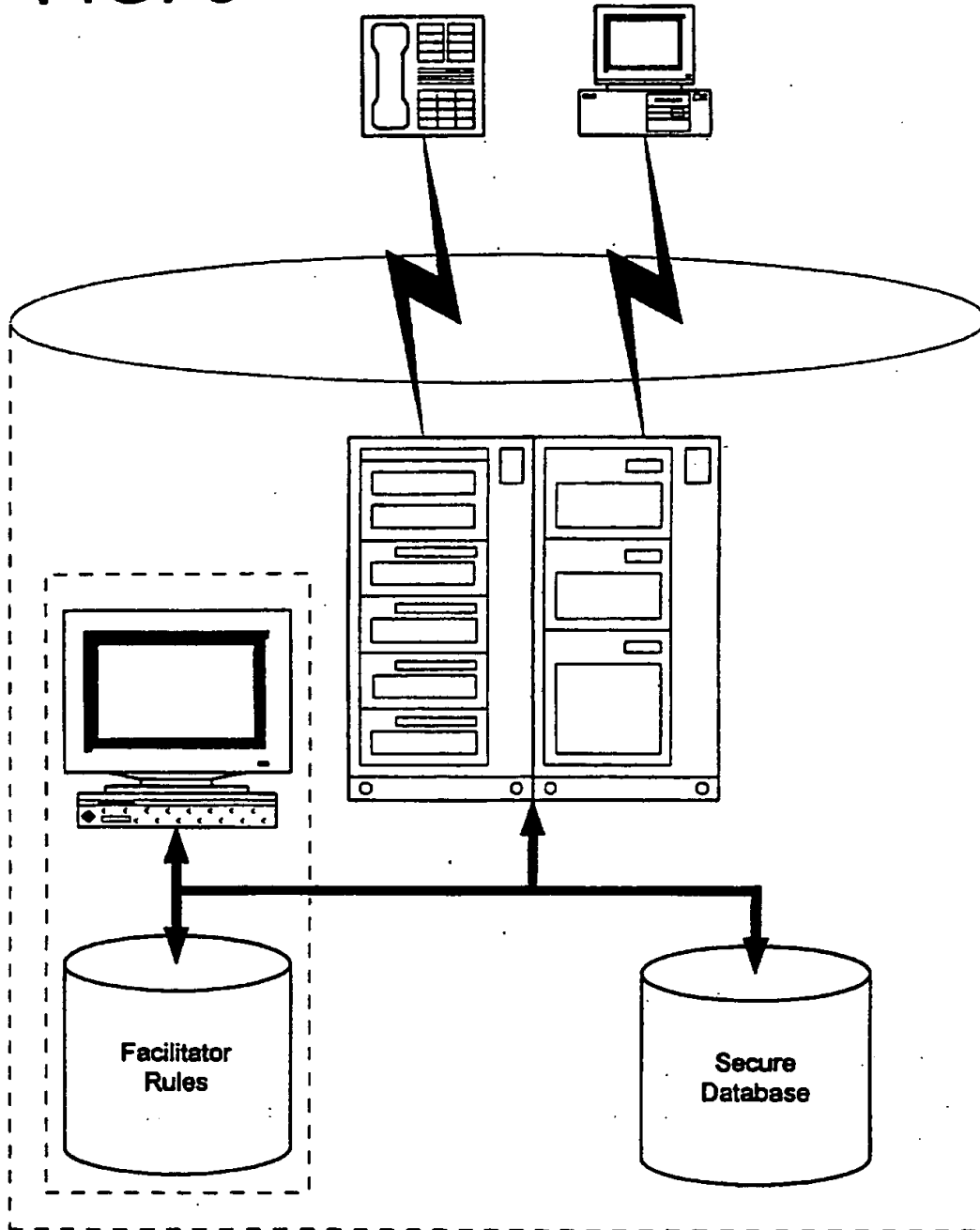
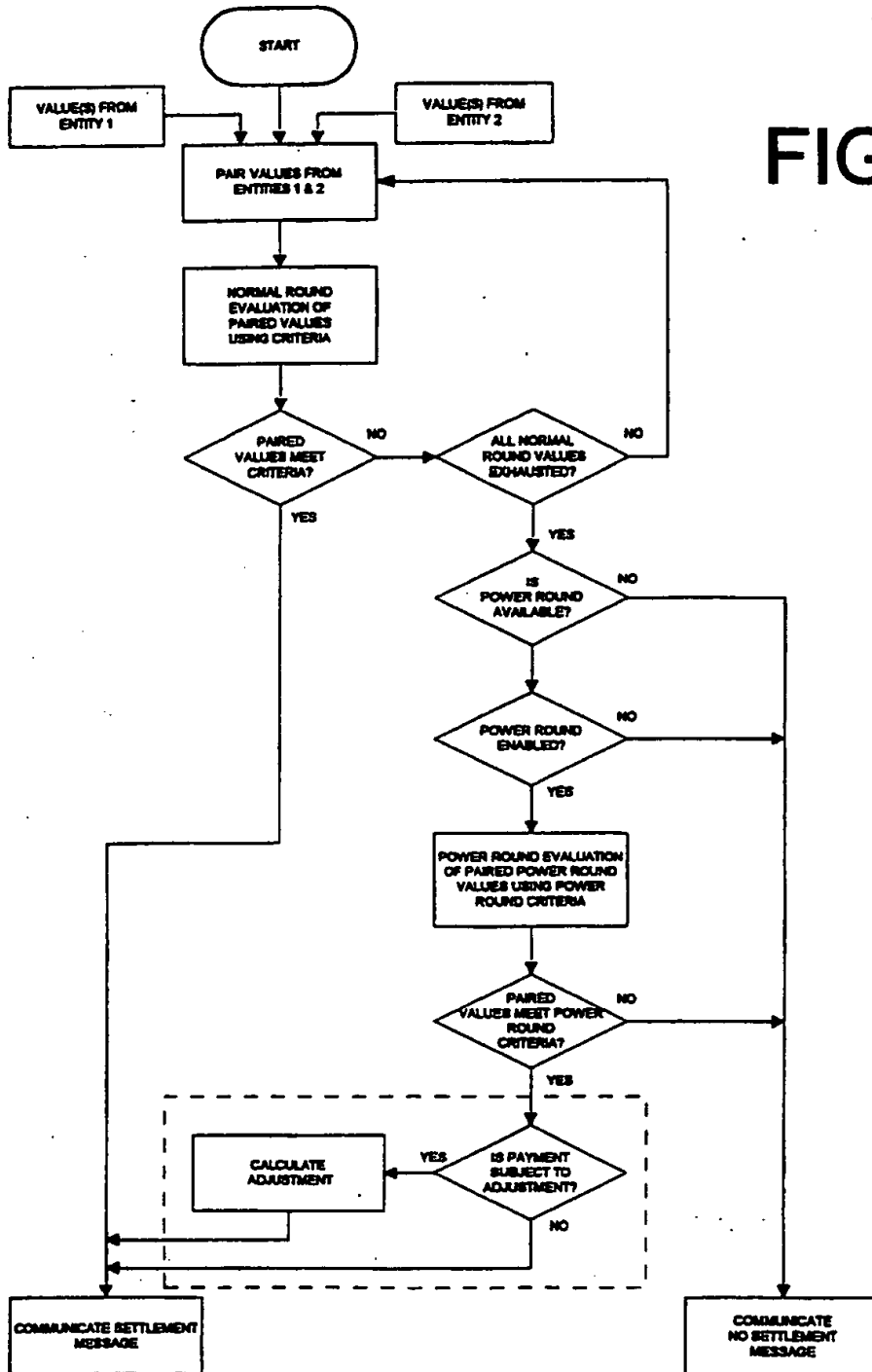

FIG. 6



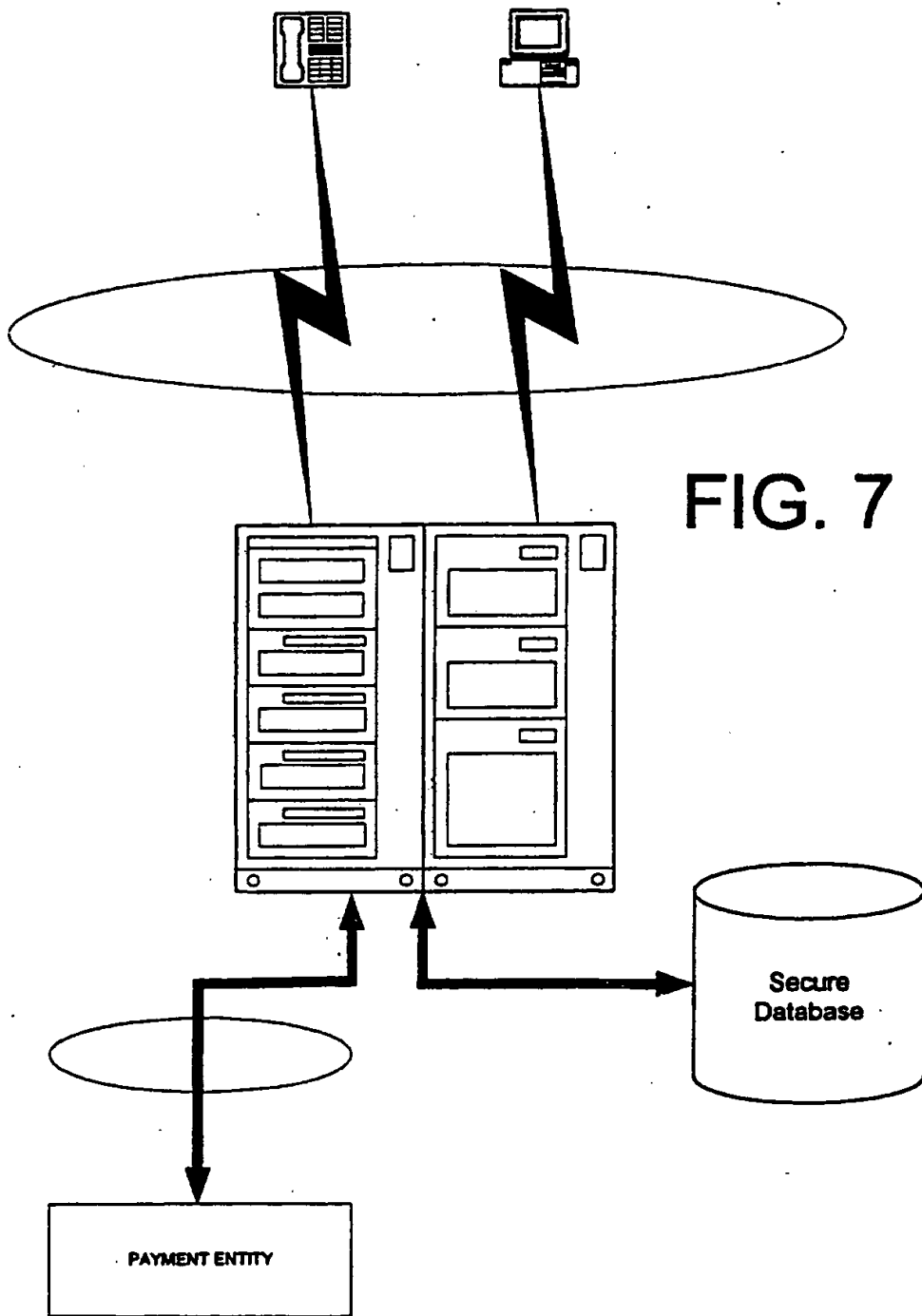

FIG. 7